

# contents

alumni update  
greetings from the chair  
faculty and staff  
retirement  
in memoriam  
class of 2007  
senior independent study  
awards and honors  
junior independent study  
physics club  
taylor bowl XVIII  
outreach  
robot invasion  
APS meeting  
summer research  
alumni news  
phun stuff

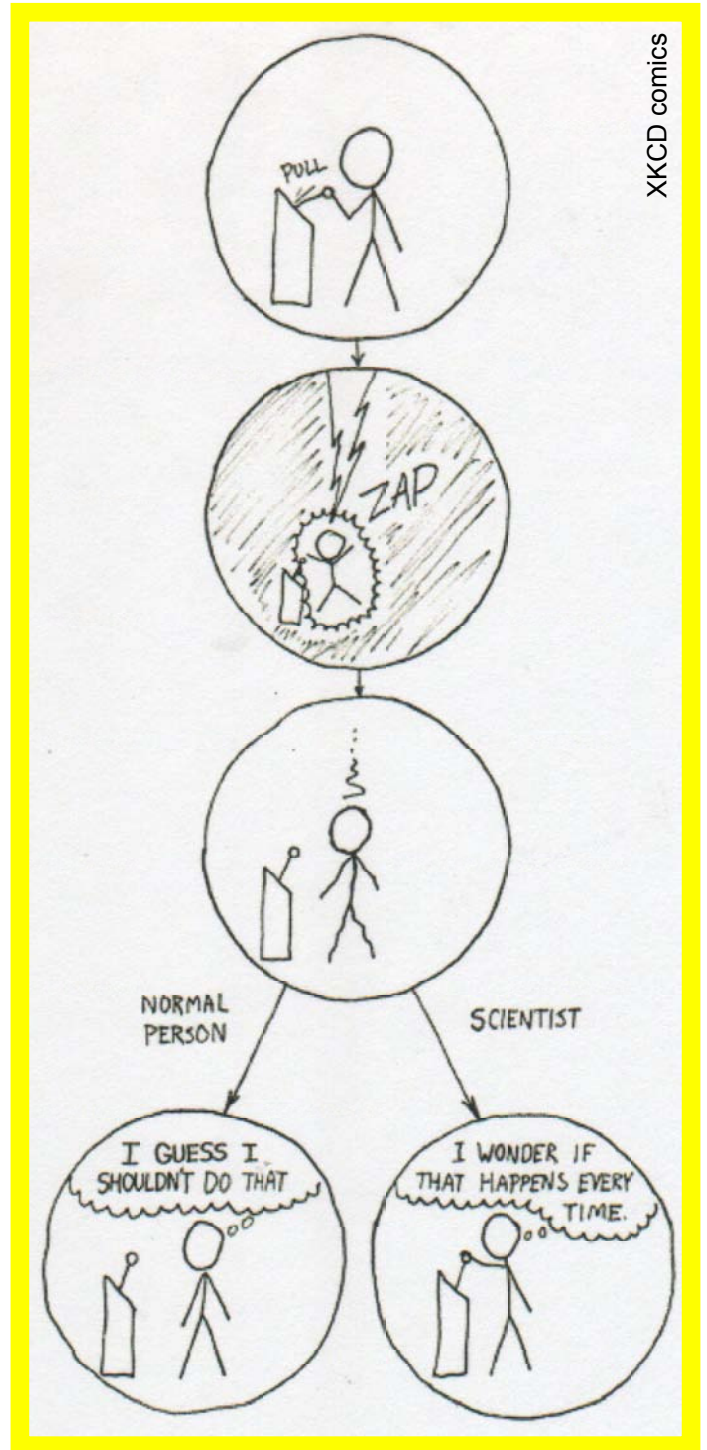

What's up with you?  
[www.wooster.edu/physics/Alumni](http://www.wooster.edu/physics/Alumni)



click on

# Alumni Update Form

Department of Physics  
308 E University St.  
Wooster OH 44691

---

THE COLLEGE OF  
WOOSTER

---

Eleventh Annual Report

September 2007

Produced by Jackie S. Middleton

On the front cover:

Stephen Poprocki and Lisa May Walker '07s present a very special Rubik's cube to their I.S. advisor, Dr. Lindner. The faces of the cube consist of graphics from their Independent Study theses.

On the back cover:

Prize won by Henry Timmers '09 at the Wolfram Research booth at the National APS Meeting: The artifact is defined by equations in *Mathematica 6* and printed to a 3D printer. The printer builds the model from the bottom up, constructing the object one layer at a time from plaster and water. The printer deposits a thin layer of plaster and then sprays a binding agent from an oversized ink-jet printer to harden the areas that form the object. Finally, the printer blows away the excess dust off and infuses the remaining object with a hardener.; Dr. Todd McAlpine, a very proud Scot, dressed up for the Senior I.S. poster session; Danny Tremblay '07 shows his fondness for classmate Joe Thomas '08; John Gamble '08, Lisa May Walker '07 and Evan Heidtmann '09 discover that playing with Legos and puzzles in Jackie's office is an effective procrastination method.

Wooster Physics Veterans & Friends:

The 2006-2007 academic year was an eventful one for the department and the College.

Don Jacobs and Susan Lehman took successive one-semester leaves. They were ably replaced by Doug Armstead. Meanwhile, Todd McAlpine replaced Shila Garg as she continues as Dean of the Faculty.

Judith Elwell, our lab technician for over a quarter of a century, retired in June. We wish Judy the very best in her retirement. We are fortunate to welcome Manon Grugel-Watson as our new lab technician. Manon is a 1999 graduate of our department, and it is great to have her back!

The sixth year of our Physics Club's outreach program was very successful, with a record number of presentations to local elementary school children. This year, our program won two national awards, a Marsh White award and a Blake Lilly prize, both from the American Institute of Physics Society of Physics Students.

Congratulations to Danny Shai for winning an NSF-REU graduate fellowship, our fourth such winner this decade. Also, congratulations to Stephen Poprocki for being an Apker finalist, our second such finalist in the last four years.

The department was well represented at the March meeting of the American Physical Society in Denver. We enjoyed the beautiful weather and meeting many of our alumni who were also at the meeting.

We had another great summer NSF-REU program, involving 10 students and 5 professors. We wish our 2007 graduates well, all eight of whom intend to begin grad school this fall. Keep in touch!

I thank Jackie for her wonderful work all year and, especially, for preparing this eleventh annual report. Alumni visit or write us when you get the chance!

— John Lindner  
Czar of Physics



# John Lindner

## The Moore Professor of Astronomy Professor and Chair of Physics



B.S., Vermont 1982;  
Ph.D. California Inst of Tech 1988;  
at Wooster since 1988

### Teaching

Fall 2006

- ✦ Modern Physics
- ✦ Modern Physics Laboratory
- ✦ Electricity and Magnetism
- ✦ Senior Independent Study (4)

Spring 2007

- ✦ Thermal Physics
- ✦ General Relativity
- ✦ Senior Independent Study (4)

### Grants Received

- ✦ "REU Site: Condensed Matter and Nonlinear Dynamics at Wooster" John Lindner (Principal Investigator), Shila Garg (Co-Principal Investigator) \$260,000 from the National Science Foundation to provide a Research Experience for Undergraduates (April 2007)

### Conference Attendance

- ✦ Nat'l Meeting of American Physical Society, Denver CO, March 2007

### Committee Service

- ✦ Grievance Committee (Chair), Goldwater Committee (Chair), College Scholars Committee, Leaves Committee

### Publications (\*student co-author)

- ✦ J. Lindner, M. Roseberry\*, D. Shai\*, N. Harmon\*, K. Olaksen\*. "Precession and Chaos in the Classical Two-Body Problem in a Spherical Universe" to appear in the International Journal of Bifurcation and Chaos.
- ✦ J. Lindner, A. Bulsara. "One-way coupling enables noise-mediated spatiotemporal patterns in media of otherwise quiescent multistable elements", Physical Review E, volume 74, 020105(R), pages 1-4 (2006).

### Invited Talks

- ✦ "Can Noise Improve Hearing? Stochastic Resonance in Hair Cells", Ohio Wesleyan University Physics Seminar (March 2007)
- ✦ "One, Two, Three, ..., Infinity: Variations on the Classical Three-Body Problem" at Wooster's Science Round Table (December 2006)

## Endowed Professorships

John Lindner was recently appointed the Moore Professor of Astronomy. The Moore Professorship was endowed in 1899 by the gift of the Reverend Robert B. Moore of Vineland, New Jersey, previously of Toledo, and a Trustee of the College from 1871 to 1874.

Shila Garg has been named the William F. Harn Professor of Physics. The Harn Professorship was established in 1958 by Miss Florence O. Wilson of Oklahoma City, Oklahoma, in honor of her uncle, William F. Harn, an 1880 graduate of the College and pioneer Oklahoman.

# Susan Lehman

Clare Boothe Luce Assistant Professor of Physics

B.A., Goshen 1993;

M.S., Ph.D. North Carolina Chapel Hill 1996; at Wooster since 2003



## Teaching

Fall 2006

- ✦ on sabbatical

Spring 2007

- ✦ Foundations of Physics
- ✦ Junior Independent Study
- ✦ Senior Independent Study (2)

## Invited Lectures

- ✦ Marietta College Physics Colloquium, "Designer Atoms: Nanotechnology and Quantum Dots," September 2006.
- ✦ Miami University Physics Colloquium, "Dot-by-Dot: Investigation of Individual Quantum Dots By Scanning Probe Microscopy," March 2007.
- ✦ Kenyon College Physics Colloquium, "Dot by Dot: Investigation of Individual Quantum Dots By Scanning Probe Microscopy," March 2007.

## Papers Presented

- ✦ "Investigation of Individual InGaAs Quantum Dots by Cross-Sectional Ballistic Electron Emission Microscopy (BEEM)," S.Y. Lehman, J.P. Pelz, C. Marginean and J.G. Cederberg, 2007 Meeting of the American Physical Society, Denver, CO, March 9, 2007.

## Conference Attendance

- ✦ 49th Electronic Materials Conference of the Minerals, Metals & Materials Society, Notre Dame IN, June 2007
- ✦ Nat'l Meeting of American Physical Society, Denver CO, March 2007
- ✦ GLCA Academic Leadership & Innovation (GALI) Institute, Ann Arbor, MI, Feb. 2007

## Publications (\*student co-author)

- ✦ Nathan J. Utt\*, S.Y. Lehman, and D.T. Jacobs, "Heat capacity of the liquid-liquid mixture nitrobenzene and dodecane near the critical point", J. Chem. Phys., to be published (Aug. 2007).

## Grants Received

- ✦ Received \$2575 equipment grant from the William H. Wilson Fund
- ✦ Received \$4000 from Howard Hughes Medical Institute (HHMI) curriculum development grant for optical tweezers experiment

# Douglas Armstead

## Visiting Assistant Professor of Physics

B.S., University of Michigan 1996;  
Ph.D. University of Maryland 2002; at Wooster since 2006

### Teaching

Fall 2006

- ✦ Foundations of Physics
- ✦ Foundations of Physics Laboratory
- ✦ Nonlinear Dynamics
- ✦ Senior Independent Study (1)

Spring 2007

- ✦ Physics Revolutions
- ✦ Foundations of Physics Laboratory
- ✦ Math Methods
- ✦ Senior Independent Study (1)

### Research Interests

- ✦ Nonlinear dynamics, chaotic billiards,  
nonlinear electronic circuits



Dr. Armstead has accepted a tenure-track position at Westminster College in New Wilmington PA beginning this fall.

# Donald Jacobs

## Victor J. Andrew Professor of Physics



B.A., M.A. University of South Florida 1971, 1972;  
Ph.D. Colorado, 1976; at Wooster since 1976

### Teaching

Fall 2006

- ✦ General Physics
- ✦ Electronics for Scientists
- ✦ Electronics for Scientists Laboratory
- ✦ Senior Independent Study (2)

Spring 2007

- ✦ on sabbatical

### Publications (\*student co-author)

- ✦ Nathan J. Utt\*, S.Y. Lehman, and D.T. Jacobs, "Heat capacity of the liquid-liquid mixture nitrobenzene and dodecane near the critical point", J. Chem. Phys., to be published (Aug. 2007).
- ✦ D.T. Jacobs, Clinton I. Braganza\*, Andy P. Brinck\*, Adam B. Cohen\*, Mark A. Lightfoot\*, Christopher J. Locke\*, Sarah J. Suddendorf\*, Henry R. Timmers\*, Angela L. Triplett\*, Nithya L. Venkataraman\*, and Mark T. Wellons\*, "Universality in 8-arm star polystyrene and methylcyclohexane mixtures near the critical point", J. Chem. Phys., to be published (Sept. 2007).

## Todd McAlpine

### Visiting Assistant Professor of Physics

M.S., Ph.D. University of Kansas, 2003, 2006  
 B.S. Edinboro University of Pennsylvania, 2000

#### Teaching

Fall 2006

- ✦ General Physics Laboratory
- ✦ Astronomy of the Solar System
- ✦ Mechanics

Spring 2007

- ✦ General Physics
- ✦ General Physics Laboratory
- ✦ Condensed Matter Physics

#### Research Interests

- ✦ Experimental characterization of semiconductor lasers
- ✦ Optical properties of materials, applied optics, and photonics
- ✦ Solar system space plasma physics and solar physics
- ✦ Computer modeling and computational physics
- ✦ Historical physics
- ✦ Physics education reform
- ✦ Supervised two NSF-REU students on research projects. The first project was the development of the initial model of a “celestial clock.” This project included technical, computational, and theoretical aspects. The second project was the development of a computer simulation of a charged spherical pendulum in electric and magnetic fields.

#### Conference Attendance

- ✦ 49th Electronic Materials Conference of the Minerals, Metals & Materials Society, Notre Dame IN, June 2007

#### Service

- ✦ Assisted the Physics Department in Assessment of Student Learning



## Shila Garg

### Dean of the Faculty

### The William F. Harn Professor of Physics

B.S., Madras (India 1970; M.S. Sussex (UK) 1972;  
 Ph.D. Kent (UK) 1975; at Wooster since 1984

#### Teaching

Fall 2006

- ✦ Senior Independent Study (1)

Spring 2007

- ✦ Senior Independent Study (1)

#### Grants Received

- ✦ “REU Site: Condensed Matter and Nonlinear Dynamics at Wooster” John Lindner (Principal Investigator), Shila Garg (Co-Principal Investigator) \$260,000 from the National Science Foundation to provide a Research Experience for Undergraduates (April 2007)





**Lee Hothem**  
Electronics and  
Instrumentation Technician  
at Wooster since 1972



**Ron Tebbe**  
Science Instrument  
Technician  
at Wooster since 2004



**Jackie Middleton**  
Administrative Coordinator  
Physics, Math & CS  
at Wooster since 1989



and we welcome...  
**Manon Grugel-Watson**  
Physics Lab Technician  
Wooster Class of 1999



# retirement

Judith Elwell retired from the College after 27 years of service as our laboratory technician. The Department honored her at a very well attended open house on May 3. Judy was presented with the book *Earth from Above* by Yann Arthus-Bertrand, signed by all the reception attendees. On Judy's last day of work, June 30, the Department present-

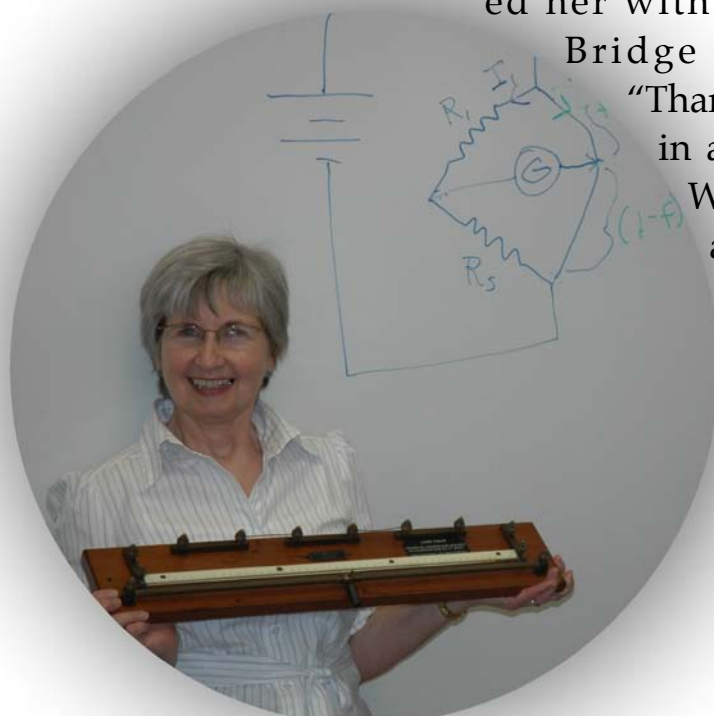

ed her with her very own Wheatstone Bridge inscribed with the words

"Thanks for meeting your potential in a balanced way for 27 years".

We will miss Judy's helpfulness and attention to detail. We extend our best wishes to Judy and her husband David as they embark on new adventures.

Budd Roswell Russell, the emeritus William F. Harn Professor of Physics at The College of Wooster, died Sunday 4 March 2007 in Columbus Ohio at the age of 87. He was born 11 August 1919 in Ridgeville Corners Ohio to the late Floyd O. and Bertha M. Russell. He was a graduate of University of Kansas and the University of Wisconsin-Madison with a Ph.D. in physics. He taught physics at the University of Pennsylvania in Philadelphia from 1947-1955 and at **The College of Wooster from 1955-1987**. In 1945, Dr. Russell was one of 70 Manhattan Project employees who signed the Szilard Petition to the President of the United States. Dr. Russell is survived by his loving wife, Wilma, whom he married 14 July 1951; his four children and their spouses, Neil (Sue) Russell of Wakefield MA, Susan (Bob) Doersam of Columbus, Nancy Russell (Carl Miller) of Columbus, and Ned (Shu San) Russell of Tucson, AZ; and five grandchildren.



*Professor Russell in spring of 1987, marveling at the retirement gift given to him by his physics students on his last day of teaching.*

**BUDD ROSWELL RUSSELL**  
1919 – 2007

# in memoriam

# class of 2007



*from left: Jon Rosch, Danny Shai, Stephen Poprocki, Mike Davis, Lisa May Walker, Nathan Utt, Danny Tremblay, Sarah Suddendorf*

**Michael Davis**

Wadsworth OH  
Chemical Physics  
Plans: Purdue University  
(Mechanical Engineering)

**Jon Rosch**

Broadview Heights OH  
Physics  
Plans: Univ of Central Florida  
(Optics)

**Sarah Suddendorf**

Port Washington WI  
Physics and Mathematics  
Plans: University of Wisconsin, Milwaukee  
(Curriculum and Instruction, Math & Physics)

**Nathan Utt**

Amherst OH  
Physics  
Plans: Purdue University  
(Agricultural Engineering)

**Stephen Poprocki**

Amherst OH  
Physics and Mathematics  
Plans: Cornell  
(Physics)

**Daniel Shai**

Fairlawn OH  
Physics and Chemistry  
Plans: Cornell  
(Physics)

**Daniel Tremblay**

Pittsburgh PA  
Physics  
Plans: Carnegie Mellon University  
(Physics)

**Lisa May Walker**

Rockville MD  
Physics  
Plans: University of Virginia  
(Astronomy)

# Good to the Last Drop: Percolation through Hypercubic and Random Lattices for Integer, Fractional, and Fractal Dimensions

Sarah J. Suddendorf

Advised by John Lindner and Charles Hampton

Percolation is the gradual movement of a liquid through a porous material, and is of vast interest to both mathematicians and physicists. This thesis investigates percolation in different dimensions through several computer simulations that were written to collect the data. The difference between a top flooded grid and a center flooded grid was investigated and was found to be negligible. The slope, or step size of the critical phenomena was studied and found to have a dependence relation with the grid size. The critical probabilities were found for integer dimensions from two through five. Fractal and fractional dimensions were also investigated, and the critical probabilities were found experimentally. Lastly, percolation was studied for a random grid. On the random grid, the percolation probability did not only depend on the vacancy probability, but rather it depended on two variables. Instead of finding a single critical probability, there was a critical relationship between the two variables. The data collected supports the theories predicted for the areas studied for this thesis.

Between One and Two Dimensions

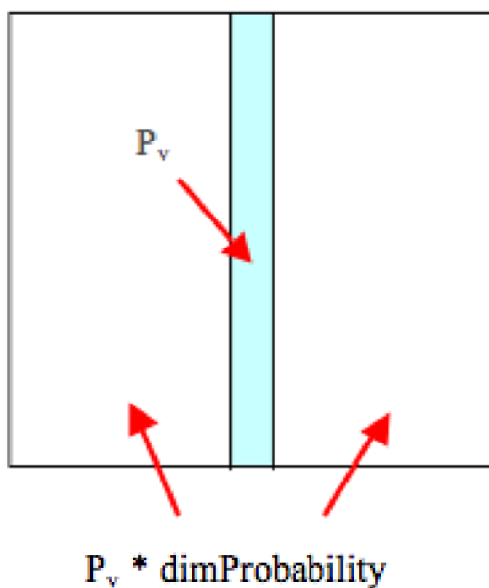

Between Two and Three Dimensions

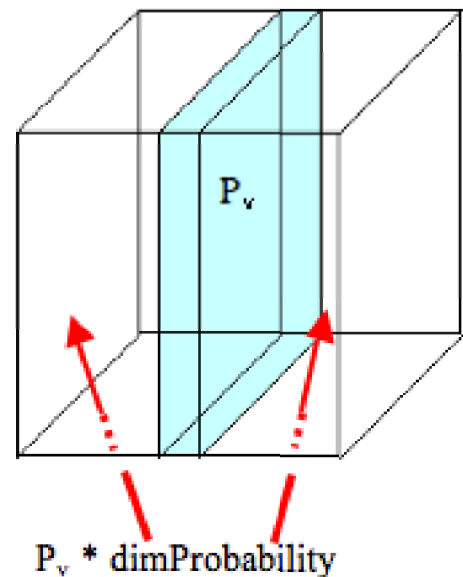

*A block diagram showing the addition of a partial dimension*

# Bayesian Source Direction Determination for Gravitational-Wave Bursts

Stephen Poprocki

Advised by John Lindner, Charles Hampton and Patrick Sutton (CalTech)

Einstein's general theory of relativity predicts gravitational waves, but although we have indirect confirmation, no direct detection of gravitational waves has been made to date. The Laser Interferometer Gravitational Wave Observatory (LIGO) is, at present, perhaps the mostly promising endeavor to detect gravitational waves. Once gravitational waves are detected it would be useful, particularly to astronomers, to know where in the sky the gravitational waves came from. In simulations, there is so far no satisfactory method of determining the source direction for generic gravitational-wave bursts. The goal of this project is to formulate a source direction estimation method based on Bayesian probability theory, and to compare the performance of this method to those in common use in the field. By constructing receiver operating characteristic curves, we show that the Bayesian method yields a large improvement over one of the standard techniques (minimization of the null energy). Our preliminary analysis also indicates that the Bayesian method is competitive with timing-based triangulation, which is currently the best known method.

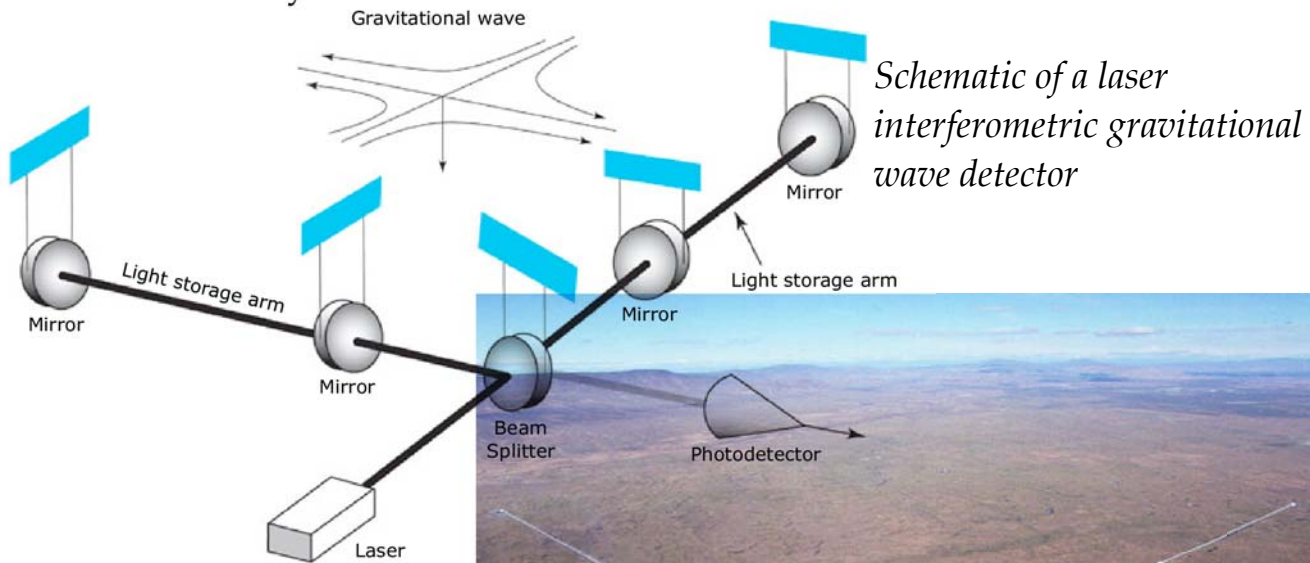

*Aerial photograph of the 4 km LIGO detector in Hanford WA*

senior independent study

# The Effects of Compression on Conducting Spheres as They Pertain to Studying Granular Percolation

Jonathan Louis Rosch

Advised by Susan Lehman and Donald Jacobs

A simplified model to explain the relation between force, contact area, and resistance for conducting spheres has been developed to aid research on granular percolation. A three-dimensional spring model has been constructed to simulate the contact between two spheres and has provided theoretical data that confirms developed theory. Physical experiments were performed with rubber balls and stainless steel beads to verify the simulation using multiple configurations. The data from the rubber ball experiment is inconclusive but the resistance measurements from the stainless steel bead experiments appeared to follow power law relationships well, but each individual bead seemed to have had minor differences that may have caused some irregularity between different sets of beads.

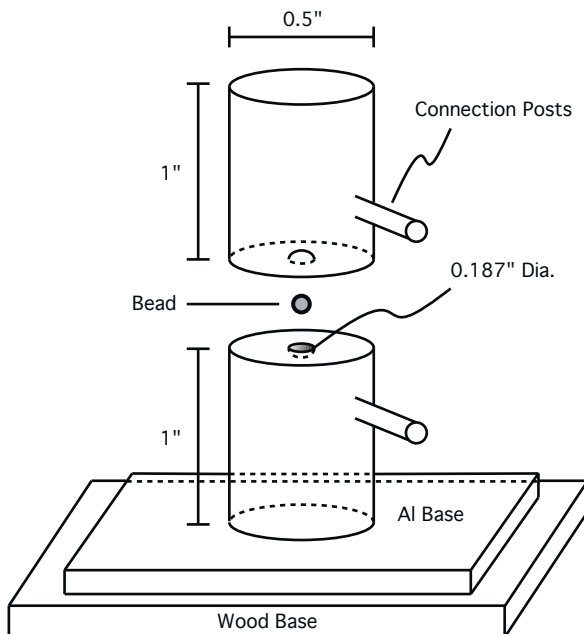
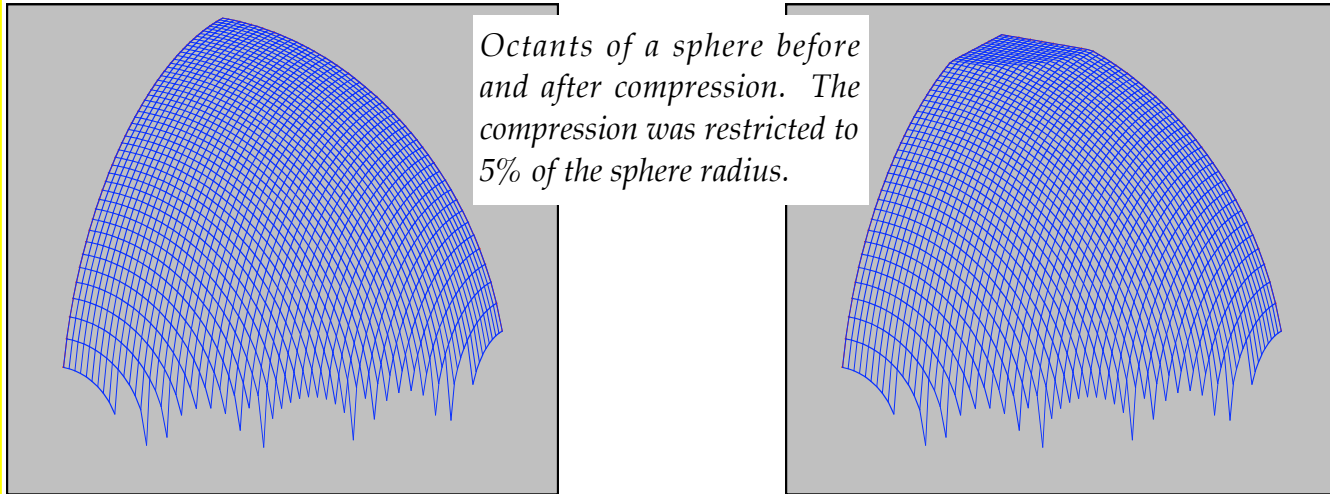

*Apparatus used for compressing small spheres. The bathroom scale used to measure applied force was placed beneath the wooden base.*

senior independent study

# Creation of a Two-Dimensional Negative-Index Material

Daniel L. Tremblay

Advised by Douglas Armstead

Metamaterials with an effective negative permittivity, permeability, and consequently a negative index-of-refraction were simulated using an FDTD method. A base geometry consisting of metal wire encased in Mylar with ferrite cross-bridges was created and used to focus divergent light with a wavelength near 7 mm. This created a material with a negative index-of-refraction both parallel and perpendicular to light propagation. The ferrite bridges were then reduced in size, both parallel and perpendicular to light propagation, to observe the effects on transmission and index-of-refraction. When varying the bridge perpendicular to light propagation, index-of-refraction varied from  $-0.402 \pm 0.041$  to  $-0.653 \pm 0.042$  and transmission was maximized at 43.3 GHz. Varying the parallel bridges exhibited a transition between transmission maximas. Bridges less than half of the full-size had maximum transmission at 40.3 GHz where the index-of-refraction varied from  $-0.752 \pm 0.039$  to  $-1.332 \pm 0.064$ . Bridges more than half of the full-size had maximum transmission at 42.6 GHz where the index-of-refraction varied from  $-0.510 \pm 0.054$  to  $-0.925 \pm 0.041$ .

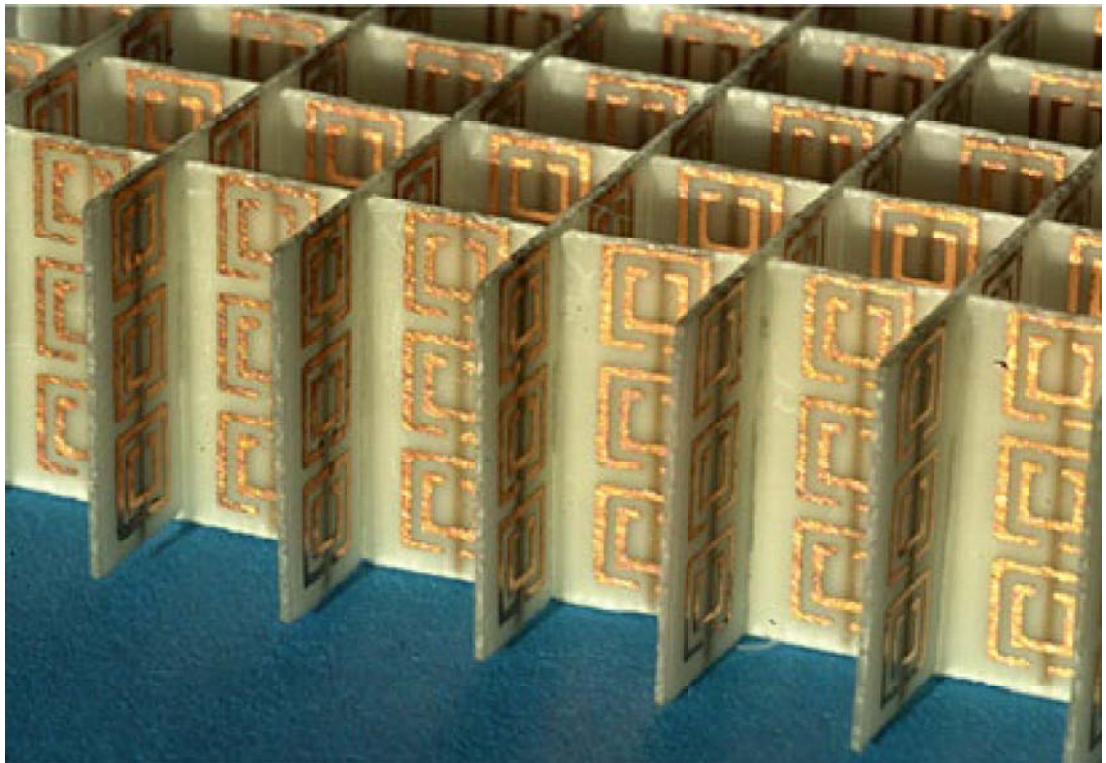

*An example of a SRR-based NIM. The wires can be seen running vertically through the SRRs.*

# Spacetime Whirlpools

Lisa May Walker  
Advised by John Lindner

Two programs were created to visualize the effect of rotating (Kerr) black holes on their surrounding spacetime. The first program, Photon Orbits, numerically integrates the null geodesics of Kerr spacetime and displays the trajectories of light rays in an interactive 3D environment. The second program, Camera, numerically integrates the null geodesics and determines the distortion of both natural and abstract background images. These programs provide visual evidence for Einstein rings, frame dragging, and the warping of spacetime near a black hole. In addition, they demonstrate that the distortion caused by a Kerr black hole is dependent on the angle of its spin axis with respect to the source.

*The setup for the photon orbits program. This shows the location of the star with respect to the black hole, as well as the coordinate system for the photons.*

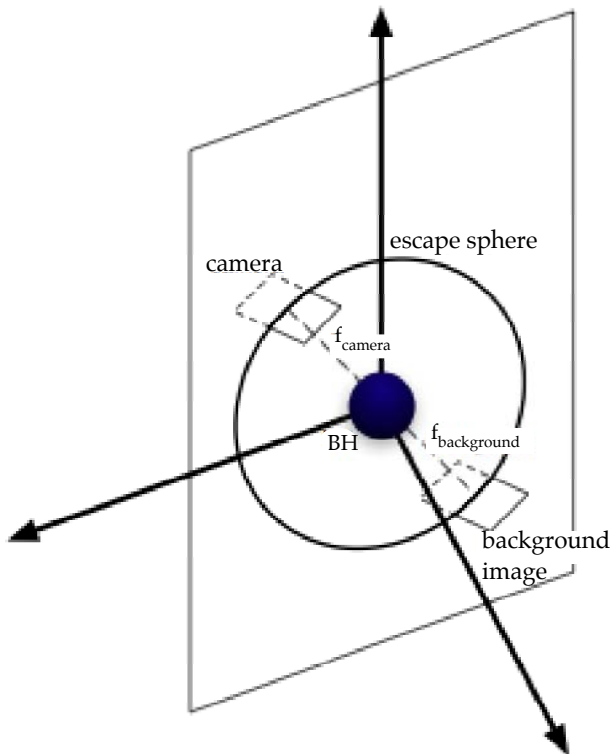
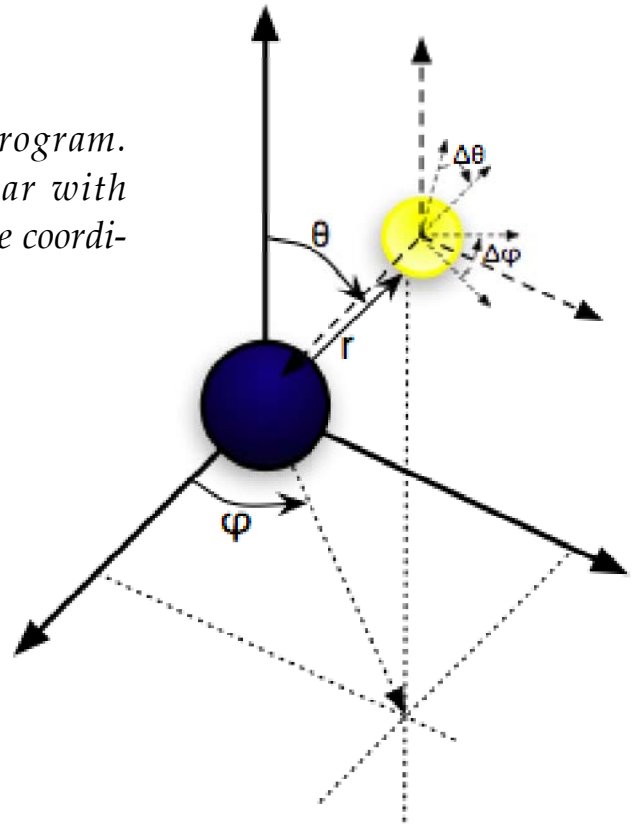

*The setup for the camera program. This shows the location of the camera and the background image with respect to each other and the black hole.*



# Monte Carlo Studies of the Globally-Coupled Ising Model

Daniel Edward Shai

Advised by John Lindner, Virginia Pett, and Sarah Schmidtke

The standard nearest neighbor Ising model is generalized to include global, long-range interactions that decay exponentially with distance. This model is used to study ferromagnetism in a variety of different lattices in 1, 2, and 3 dimensions. This computationally difficult problem is approached using Wang-Landau Monte Carlo simulation, where the density of states of a system is calculated, rather than using standard importance sampling techniques such as Metropolis Monte Carlo. Results indicate that the ferromagnetic to paramagnetic phase transition is stabilized by long-range interactions, despite the destabilizing effects of the lattice boundaries. The phase transition behavior is separated into two distinct regions. When the coupling is local, infinite lattice behavior is observed, and when the coupling is global, finite size effects are prevalent. The phase transition temperature appears to scale with the lattice packing efficiency and the total number of atoms, in the global coupling regime.

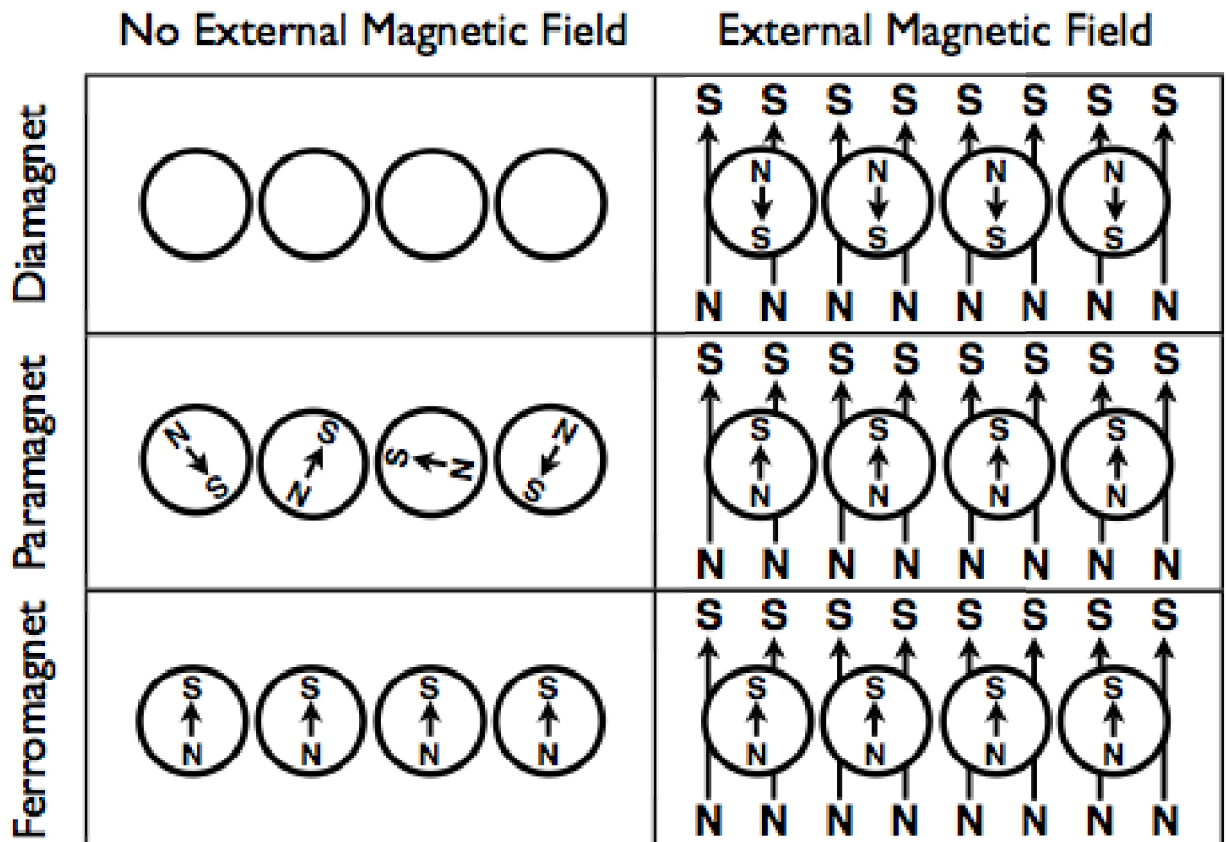

*The behavior of diamagnetic, paramagnetic, and ferromagnetic materials both with and without the presence of an external magnetic field.*

# An Investigation of Dielectric Permittivity as Related to Concentration in Mixtures of 7CB and MBBA

Michael Christopher Davis  
Advised by Shila Garg

This study measured the effects on dielectric permittivity by changing concentrations of a mixture between 4-n-heptyl-4'-cyanobiphenyl, 7CB, and 4-methoxybenzylidene-4-butylaniline, MBBA. For each mixture, the phase transition was recorded using a digital video camera, while the temperature was monitored using a thermistor and the computer program LabVIEW. Using the reduced temperature of 0.015, we calculated a temperature for each mixture that was in the nematic phase proportional to all the other concentrations. At the calculated temperatures we measured epsilon perpendicular and epsilon parallel by modeling the liquid crystal cell as a capacitor and resistor in parallel. Epsilon parallel and epsilon perpendicular gave reliable results when compared to the literature values of pure 7CB. Delta epsilon showed a distinct exponential decay as the concentration of 7CB in the mixture decreased. When compared to a similar mixture of 5CB-MBBA, the values for delta epsilon are almost identical for each concentration.

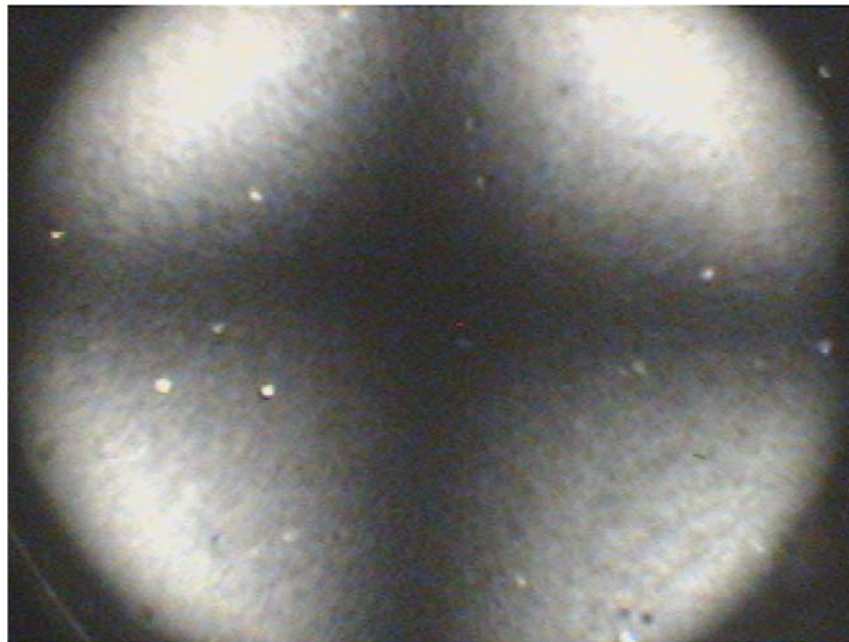

*Dark "cross" seen from viewing homeotropic alignment with Bertrand lens.*

# Heat Capacity Anomaly in a Nitrobenzene+Dodecane Mixture

Nathan Joseph Utt

Advised by Donald Jacobs and Susan Lehman

The isobaric heat capacity anomaly of a nitrobenzene+dodecane mixture at the critical concentration was measured using adiabatic calorimetry. Data were collected using the step technique to be able to quantify any heat leaks that occurred in the calorimeter. The temperature differences between steps were analyzed using the method of linear projections where the small slopes in the flat part of the temperature step were forced to vary smoothly. This technique produced heat capacity data that were not affected by temperature drifts in the calorimeter. Three data runs were collected at different scan rates to prove reproducibility. The heat capacity data from one run was accurately fitted to the theory with the critical exponent  $\alpha$  set equal to 0.11 and the amplitude ratio forced to be 0.53. The critical temperature was determined to be  $28.889 \pm 0.001^\circ\text{C}$  and the one-phase amplitude was  $0.0102 \pm 0.0003 \text{ JK}^{-1}\text{cm}^{-3}$ . Two-scale factor universality was used to determine a correlation length amplitude of  $0.294 \pm 0.003 \text{ nm}$ , which is significantly different than a previously published value. This implies that either the published value is incorrect or two-scale factor universality is not valid. A similar discrepancy, however, has been previously observed in other correlation length amplitudes reported by this same group, causing us to suspect the former of the two possibilities. Because of the unreliable value for correlation length amplitude we were unable to test the value of the two-scale factor universality constant  $X$ .

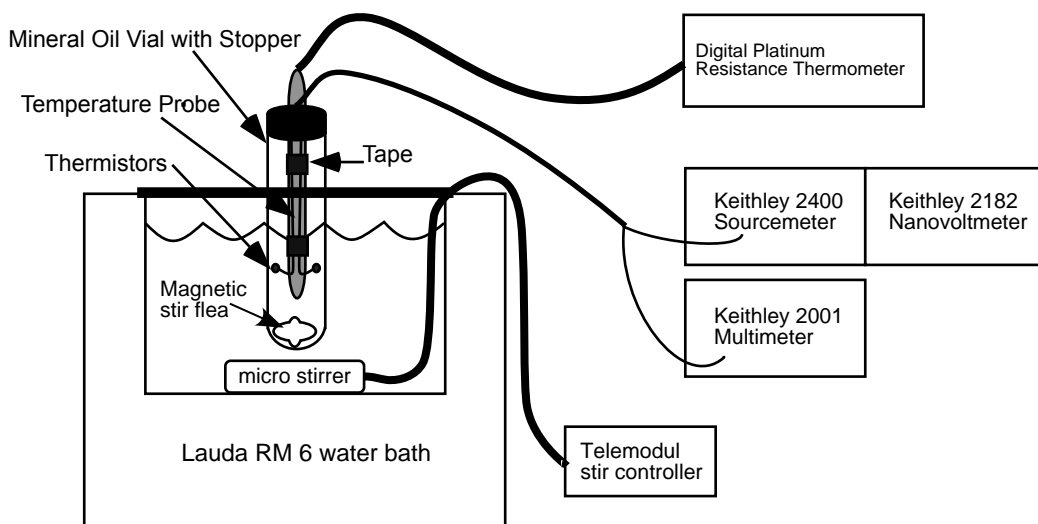

*Diagram of the thermistor calibration equipment*

**Kelly Marie Patton '08**

*The Mrs. Alva C. Bailey Scholarship Fund* was established in 1981 by the Women's Advisory Board to honor Mrs. Bailey, a member of the College's Board of Trustees from 1941 to 1975. The scholarship is awarded annually to a young woman entering her junior year.

**Henry Robert Timmers '09**

*The Joseph Albertus Culler Prize in Physics*, established in 1942, recognizes excellence in the field of Physics. The prize is awarded to the first- or second-year student who has attained the highest rank in general college physics.

**Evan Z. Heidtmann '09**

*The Elias Compton Freshman Prize*, established in 1926, honors the first Dean of The College of Wooster, and recognizes academic excellence in the first-year class. The prize is awarded to the student who has achieved the highest standing in scholarship during the first year.

**Nathan Joseph Utt '07**

*The Mahesh K. Garg Prize in Physics* is awarded annually to an upper-class physics major who has displayed interest in and potential for applying physics beyond the classroom.

**Kelly Marie Patton '08**

*The Edward Taylor Prizes* were established in 1876 by A.A.E. Taylor, President from 1873-83. The prizes are awarded to students who have attained the highest and second highest academic standing during their first-year and sophomore years.

**Stephen Thomas Poprocki '07**

**Daniel Edward Shai '07**

*The Arthur H. Compton Prize in Physics* established in 1928 by members of the class of 1913 in honor of Dr. Compton, who received the Nobel Prize in Physics in 1927. Awarded to the senior physics major attaining the highest standing in that subject.

**Stephen Thomas Poprocki '07**

**Daniel Edward Shai '07**

*Phi Beta Kappa*

**Jonathan Louis Rosch '07**

**Daniel Lindell Tremblay '07**

**Lisa May Walker '07**

*Cum laude*

**Stephen Thomas Poprocki '07**

**Daniel Edward Shai '07**

*Summa cum laude*

**special kudos...**

# of 2007 Wooster physics graduates = 8

# of 2007 Wooster physics graduates attending graduate school = 8

8/8 = 100% graduate school attendance!

**congratulations!**

## *NSF Graduate Research Fellowship*

### *Danny Shai '07*

Danny Shai, a rare physics and chemistry double major, has been awarded a graduate research fellowship from the National Science Foundation. His proposal was based on his Senior I.S. research on ferromagnetism. Danny will enroll in the physics Ph.D. program at Cornell University this fall. Danny is the fourth recent physics major to receive a National Science Foundation Graduate Fellowships (others in 2001 and 2003). He served as vice president of the Physics Club and president of the Chemistry Club. This past summer, Danny worked as a graduate research associate in our department's NSF-REU summer research program.



## *American Physical Society Apker Award Finalist*

### *Stephen Poprocki '07*

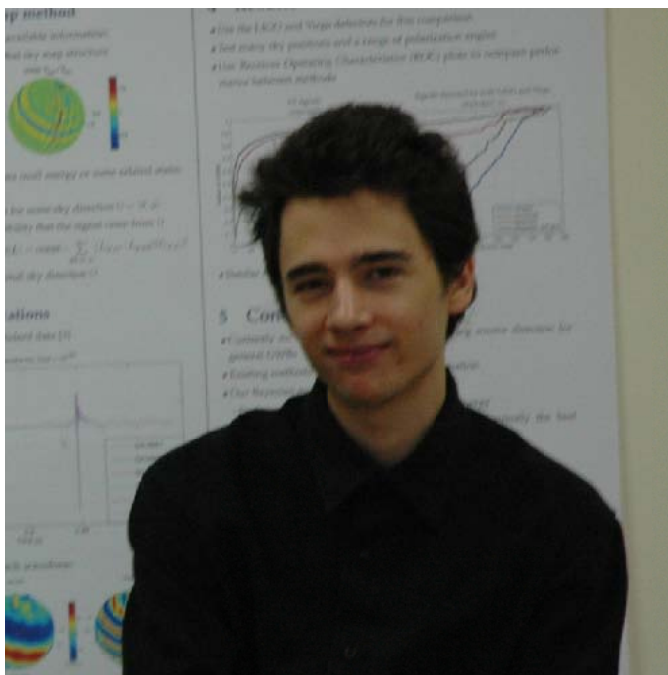

Stephen Poprocki is a finalist for the American Institute of Physics Leroy Apker Award, which recognizes "outstanding achievements in physics by undergraduate students, and thereby provides encouragement to young physicists who have demonstrated great potential for future scientific accomplishment." Stephen is the second Wooster physics major to be a finalist for the award; the first being Jeff Moffitt '03. Stephen will travel to Washington DC this September to meet the Apker Selection Committee, and he will present his senior independent study research on using Bayesian statistics to detect gravitational waves. Stephen will begin graduate school at Cornell University this fall.

# Junior I.S. Self-Designed: The Mpemba Effect: Studying the effects of initial temperature, evaporation, and dissolved gasses on the freezing of water

Joseph Thomas

An investigation into the Mpemba Effect was performed by studying the effects of initial temperature, evaporation, and dissolved gasses on the freezing of water. Precision thermistors were used to measure the temperature of three different samples of water in a freezer held at  $-12.0 \pm 0.5^\circ\text{C}$ . The time it took the sample to completely change to ice was measured. This point could be found using the latent heat of fusion. The time for the sample to reach  $0^\circ$  was also measured. Data was collected for both water that is initially warm, and water that had been previously heated and then allowed to cool. In all cases the water was massed before and after the data collection to determine the effect of evaporation. It was determined that the Mpemba effect is widely reproducible, and the evaporation of mass from the samples was negligible. The conclusion was reached that the expulsion of dissolved gasses from the sample during the heating process resulted in the appearance of the Mpemba effect.

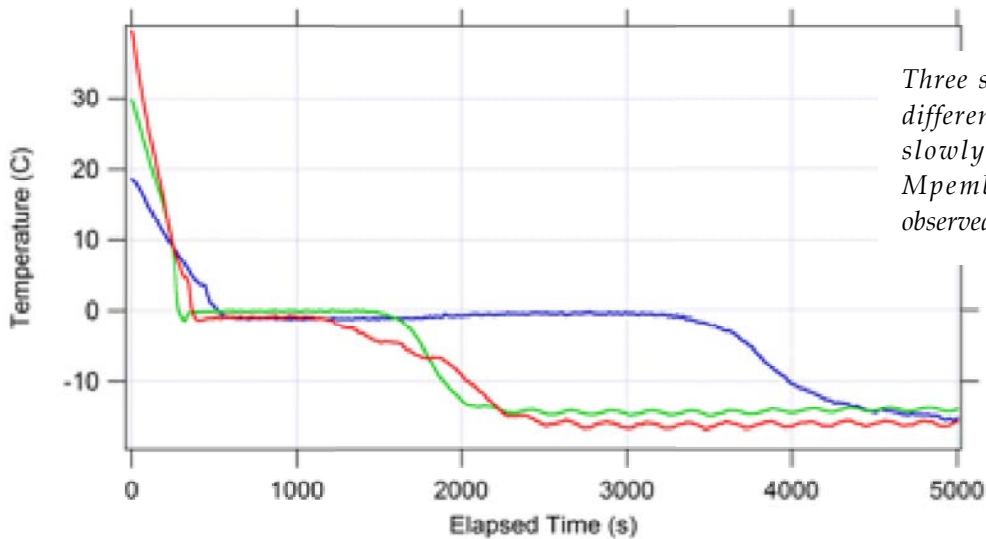

Three samples were heated to different initial temperatures slowly on a hot plate. The Mpemba effect was clearly observed in this data run.

The water is completely frozen at the point indicated, as a new minimum in the data was achieved., followed by consistent lower minima. This was the first time the temperature crossed  $-2^\circ$ , which it had come very close to several times before. During the freezing  $-1.8^\circ$  was a consistent minimum.

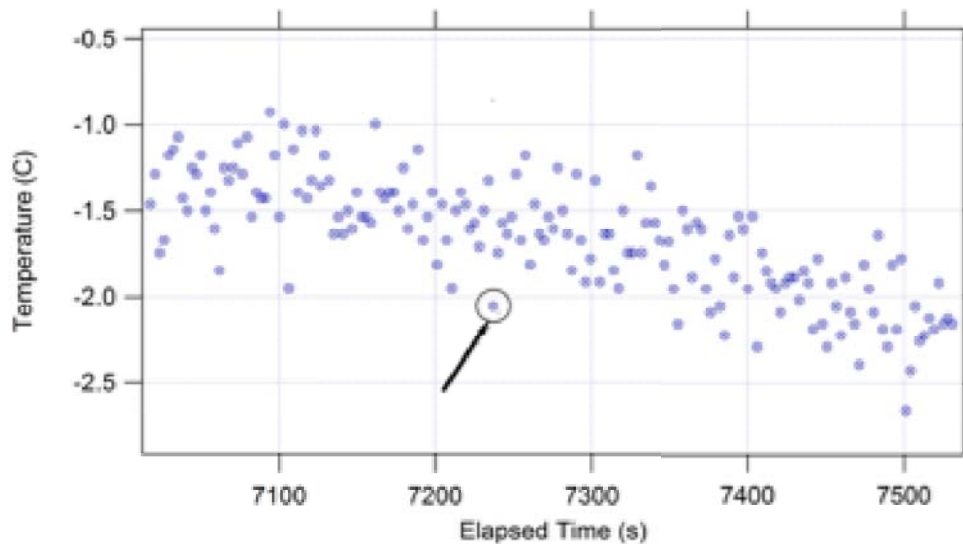

# Junior I.S. Self-Designed: Studying the Effects of Filling a Helmholtz Resonator with Spheres

Kelly Patton

A Helmholtz resonator, consisting of a resonating cavity with an open neck, was filled with spheres to determine the effects on the resonant frequency. A function generator and speaker were used to excite the resonator, and Fourier analysis was used to find the resonant frequency. Two sizes of marbles, glass beads, and water were used separately to fill the resonator. Frequency measurements were made at a wide range of open volumes by filling the resonator with different amounts of spheres. The volume of the spheres and the distance from the top of the resonator to the top of the spheres were measured as well. Comparisons of the resonant frequencies of spheres and water at the same height were investigated. It was found that the resonant frequency for water was much higher than the resonant frequency for spheres at the same height, indicating that the air pockets in between the spheres are having an effect on the resonant frequency. In addition, the change in frequency as a function of open volume for both the water and the spheres was studied. A peak in the resonant frequency for the spheres was observed at a certain critical open volume, approximately half of the total volume of the resonator. This effect is contrary to the theoretical dependence of frequency on open volume. The most likely explanation is that a correction is needed in the theory, as the simplest case no longer holds.

*A Helmholtz resonator can be thought of as a mass on a spring system. The air pressure acts as the spring, while the air inside the neck is the mass. The driving force is provided by an external sound wave.*

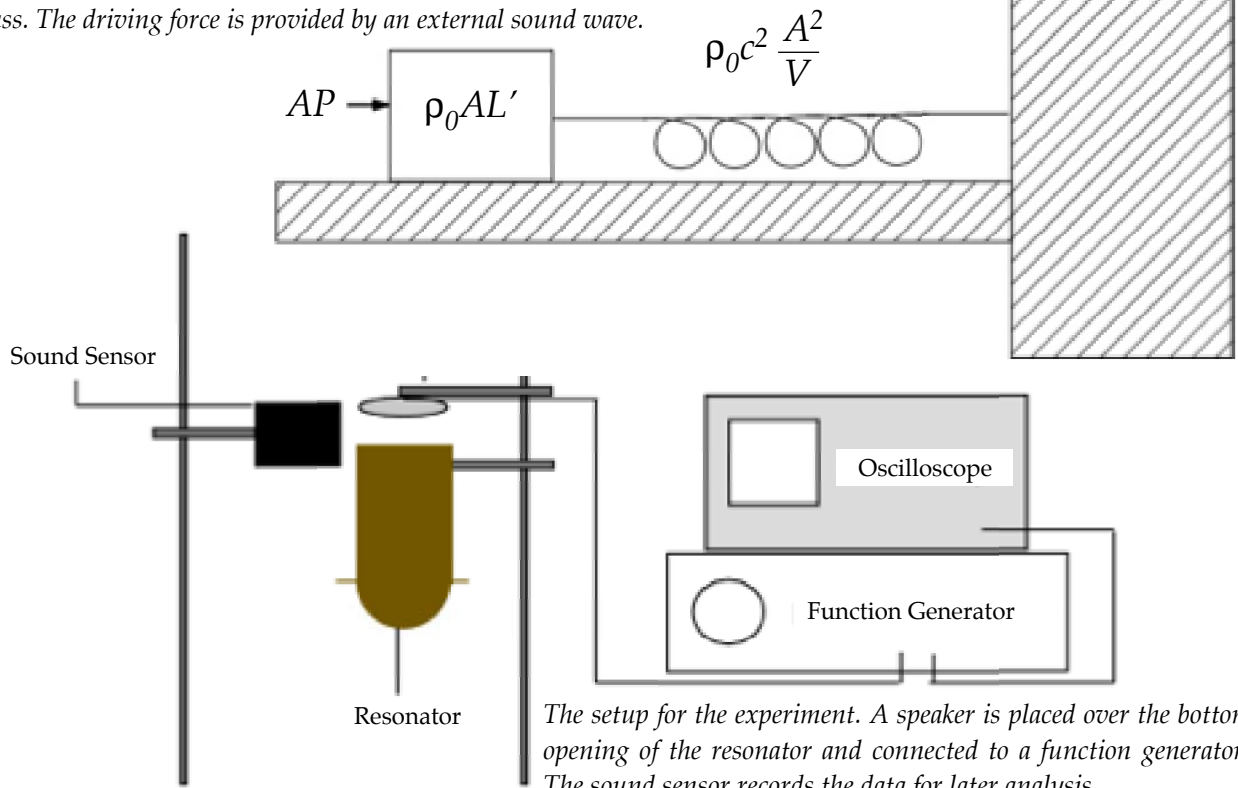

*The setup for the experiment. A speaker is placed over the bottom opening of the resonator and connected to a function generator. The sound sensor records the data for later analysis.*

# Junior I.S. Self-Designed: Simulating Gravity Between Two Non-spherical Objects

Mark Wellons

A program was constructed that could simulate two rigid, irregular bodies in circular orbits interacting through the force of gravity. To model the bodies, they were internally represented as cuboid cellular lattices. The program was not a success, as it could only maintain stability for systems that were very symmetric or very close to symmetric. Deviations in the starting positions resulted in fluctuations in the total system energy and the eventual collapse of the orbits. Whether this is due to a fundamental flaw in the algorithms, a semantic error in the code, or just the cumulation of integration error is unknown. When the program does maintain stability, it verifies that two identical lattices with symmetric starting orientations rotated in regular orbits and changed spins at regular intervals, and that lattices that start with asymmetric starting conditions behave chaotically.

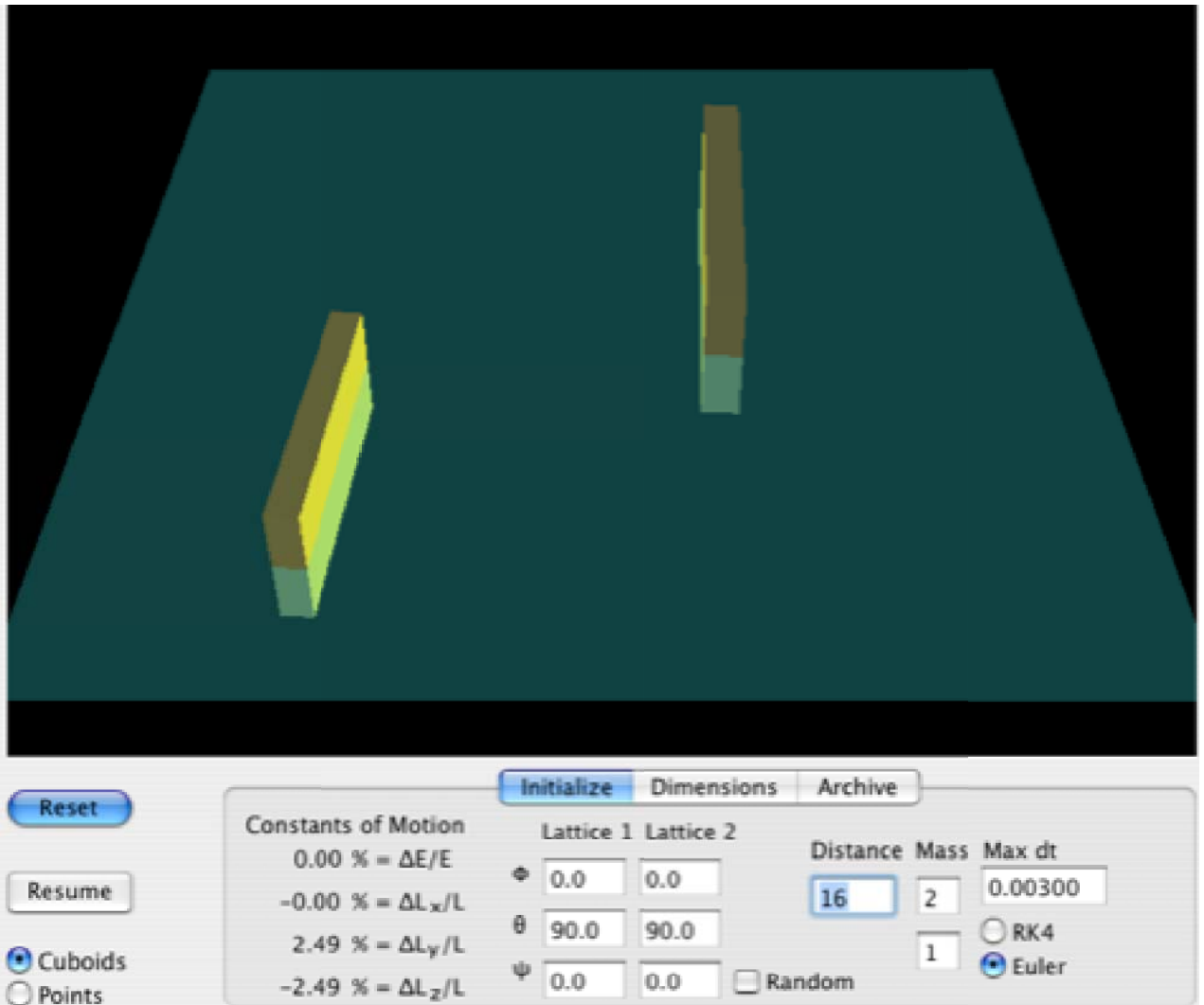

*The default viewing screen of Cuboid Stars. All the controls are on the bottom, and the motion of the lattices is drawn in the top.*



# Junior I.S. Self-Designed: The Effects of Moons on Saturn's Ring System

Kirsten Larson

The ring system of Saturn is a complex interaction between numerous particles, moons, and Saturn. A program was created to simulate the different aspects of the ring system and to study the effects of moons on the orbiting particles. Simply by considering both the force of gravity on each particle and collisions between particles, gaps formed at eight different resonant positions. I also studied the effects of collision elasticity and found that less elastic collisions cause the gaps to form more quickly. Furthermore, the effects of shepherding were studied by embedding an orbiting moon in the ring particles. By varying the mass ratio of Saturn to the moon, it was found that the smaller the mass ratio between Saturn and the moon, the larger the gap cleared in the ring and the larger the width of the ringlet formed in the center of the gap. It was also observed that resonances interior to the moon controlled the interior edge of gaps while resonances exterior to the moon controlled the exterior edge of the gaps.



*Drawings by Galileo of his observations of Saturn*

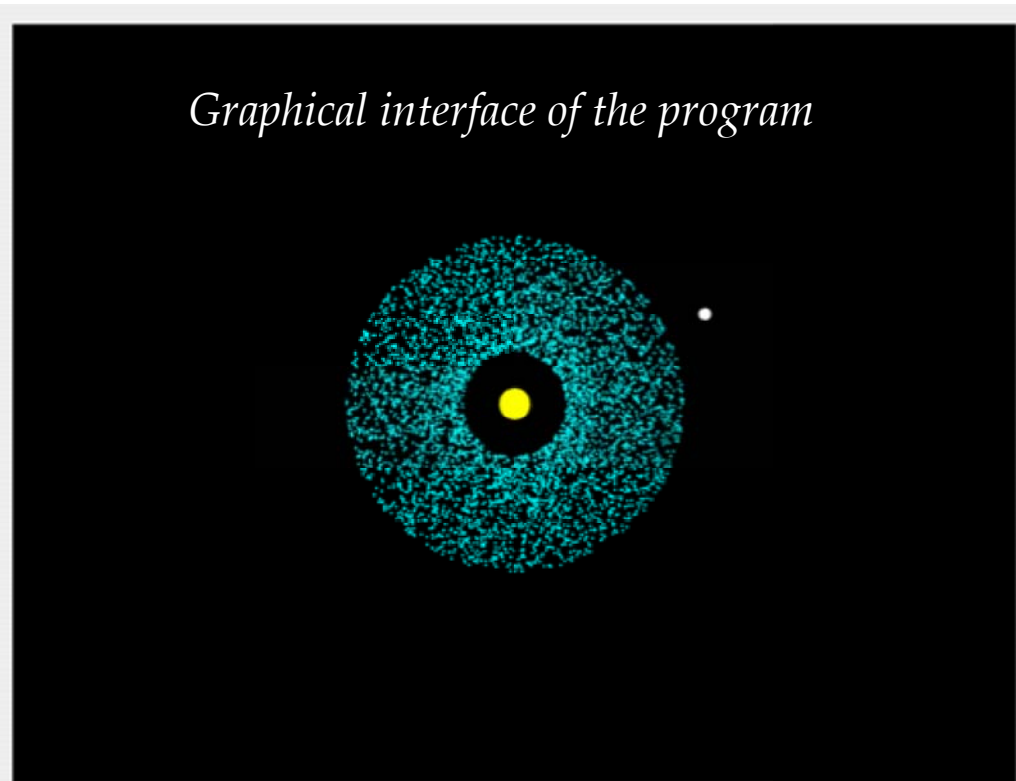

Reset

Pause

Draw Cassini Division

Collisions Dynamics Time Archive

Saturn's Mass =	100,000	number of Particles =	5,000
Mimas's Mass =	100	Inner ring diameter =	0.250
Separation =	150	Outer ring diameter =	0.800

junior independent study

# Junior I.S. Self-Designed: Why humans can't fly on Earth

Howard Henry

The force per surface area created by the flapping motion of a working model of a dragonfly wing is analyzed. An equation for the force generated to keep the dragonfly at equilibrium is given by Bernoulli's equation. Using thrust force generated by its wings the dragonfly remained stationary attached to a cart resting on a frictionless incline. The relationship between the wingbeat frequency  $n$  and the thrust force  $T$  was determined and plotted on a linear curve. By studying this relationship, the force required to generate propulsion of a human size scaled model of the dragonfly can be determined. A number of factors however restrict the feasibility of creating a working human size model of a dragonfly. These factors include the stress and strain on the material of the wing operating under burdensome conditions. Another major factor is the physiological requirement of a human to generate the necessary forces for a period of time.

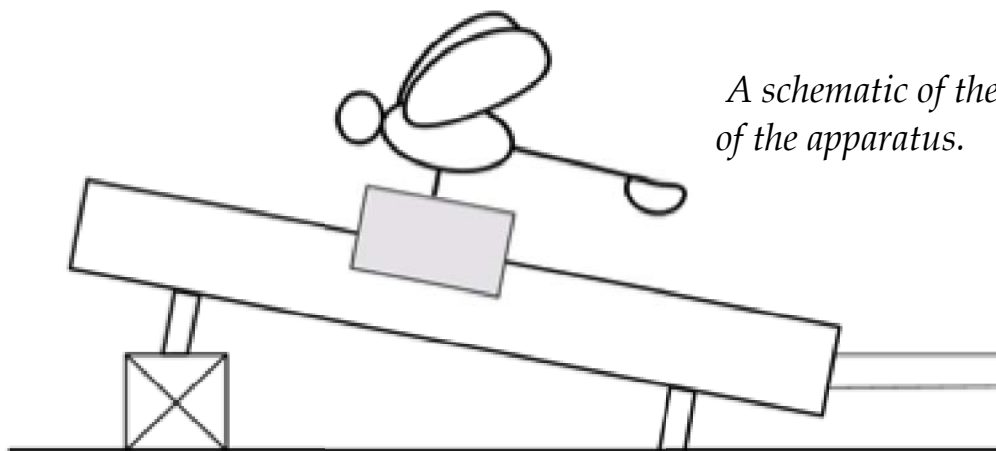

*A schematic of the setup of the apparatus.*

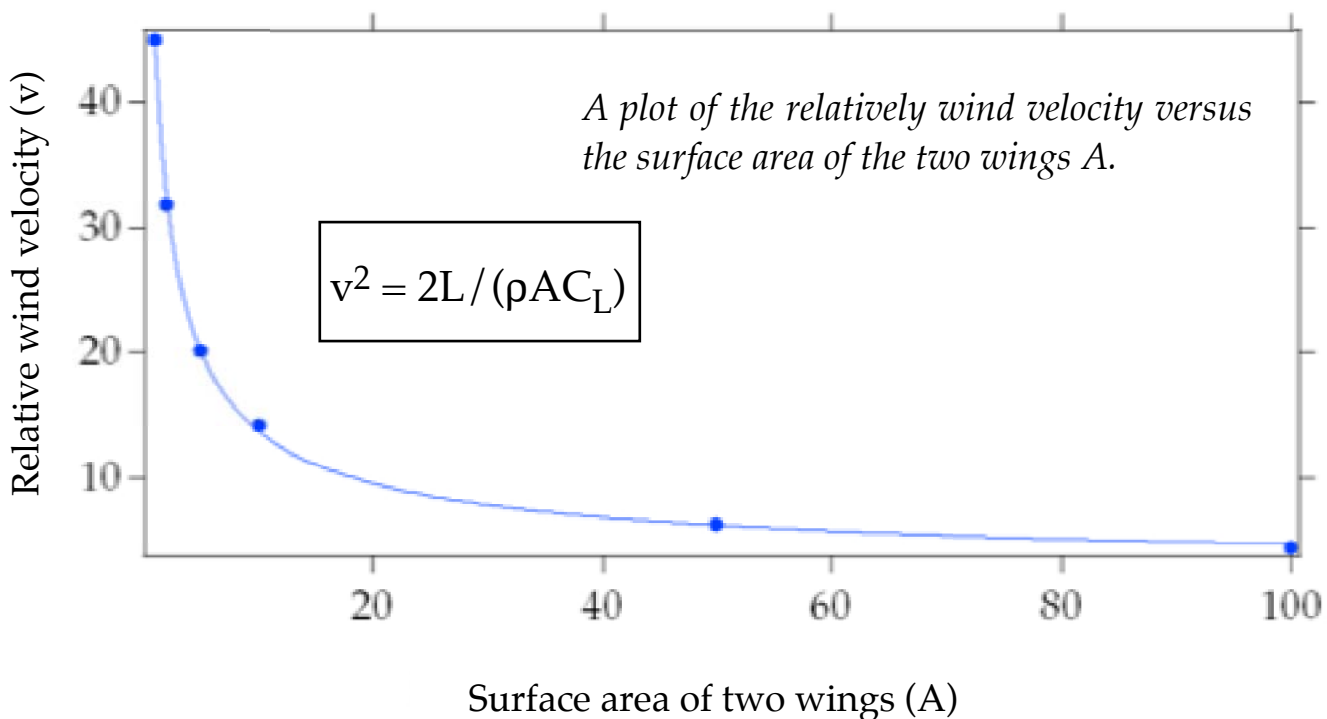

*A plot of the relatively wind velocity versus the surface area of the two wings  $A$ .*

$$v^2 = 2L / (\rho A C_L)$$

Junior I.S. Self-Designed:

# Using toy dynamos to model the Sun's magnetic field

John Gamble

We attempt to shed light on the solar dynamo problem by idealizing the sun as a simple system of Faraday disk dynamos. We first investigate and observe Bullard's simple single-disk system, showing that it is not capable of polarity reversal, which renders it ineffective as a model for the solar dynamo. We then move to Rikitake's system of coupled Bullard dynamos and explore its characteristic chaotic current reversal. Afterwards, we address the damping concerns brought forth against the Rikitake system by Raymond Hide, and show that we can regain at least periodic current-reversals, even in the presence of a damping force. Finally, we discuss the possibility of modifying the Rikitake dynamo into a geometry more similar to that of the sun. To do this, we begin by moving the system coaxial, which unfortunately eliminates current reversal. In an effort to facilitate the development of new models that might regain polarity reversal, we then derive a formula for calculating the mutual inductance for an arbitrary system, and explicitly calculate the mutual inductance for a disk and wire loop.

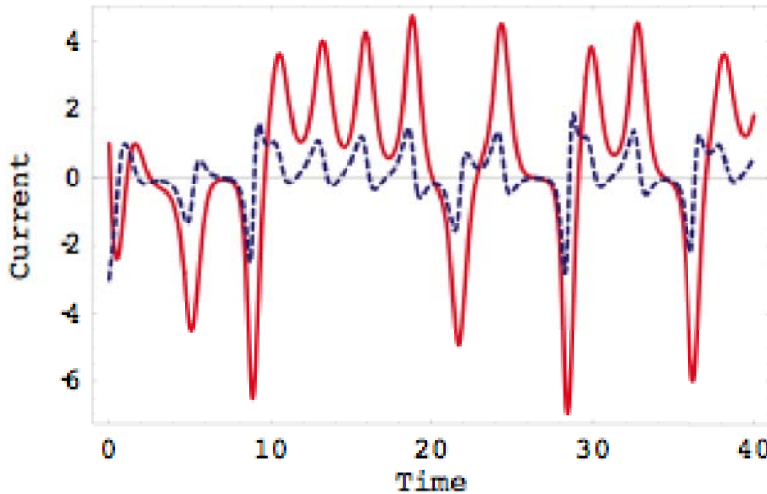

*Numerical simulation of the Rikitake system.*

*Phase-space plot of the first disk in the numerical integration done above.*

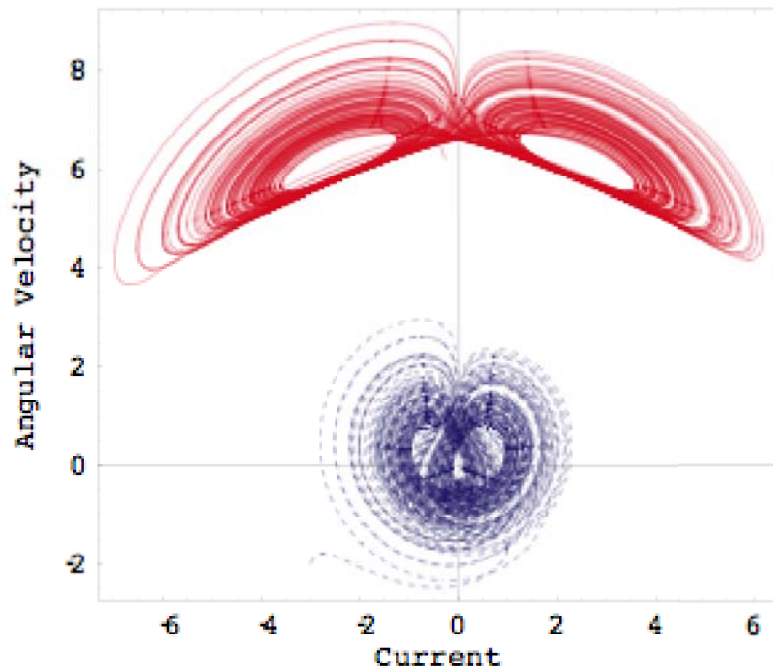

# Junior I.S. Self-Designed: Modernizing the Cavendish Experiment

Mateo Chinchilla

Using a torsion balance, much like the one used in 1798 by Henry Cavendish, one can calculate the gravitational constant expressed in Newton's law of universal gravitation. This law states that the attraction between two objects is inversely proportional to the square of the distance between them. The apparatus consists of a horizontal pendulum, which hangs from a torsion wire and has two small spheres attached at either end. By bringing two larger spheres into the proximity of the two small spheres the force of attraction can be observed. To quantify the observations a laser is reflected from a small mirror mounted on the pendulum. As the pendulum oscillates due to the attracting force, the angle about which it oscillates is calculated by observing the position of the reflected laser. Although Cavendish performed his experiment with the limited technology he had at the time, today the experiment can be made simpler with the development of computers. Using a position sensitive detector to act as a virtual ruler, the position of the reflected light beam is automatically detected as it oscillates, making the data collection procedure automated, saving the experimenter time and effort. With this improved technique, I measured the gravitational constant to be  $6.3 \pm 0.3 \times 10^{-11} \text{ Nm}^2\text{kg}^2$  which only has a 5.1% difference from the accepted value.

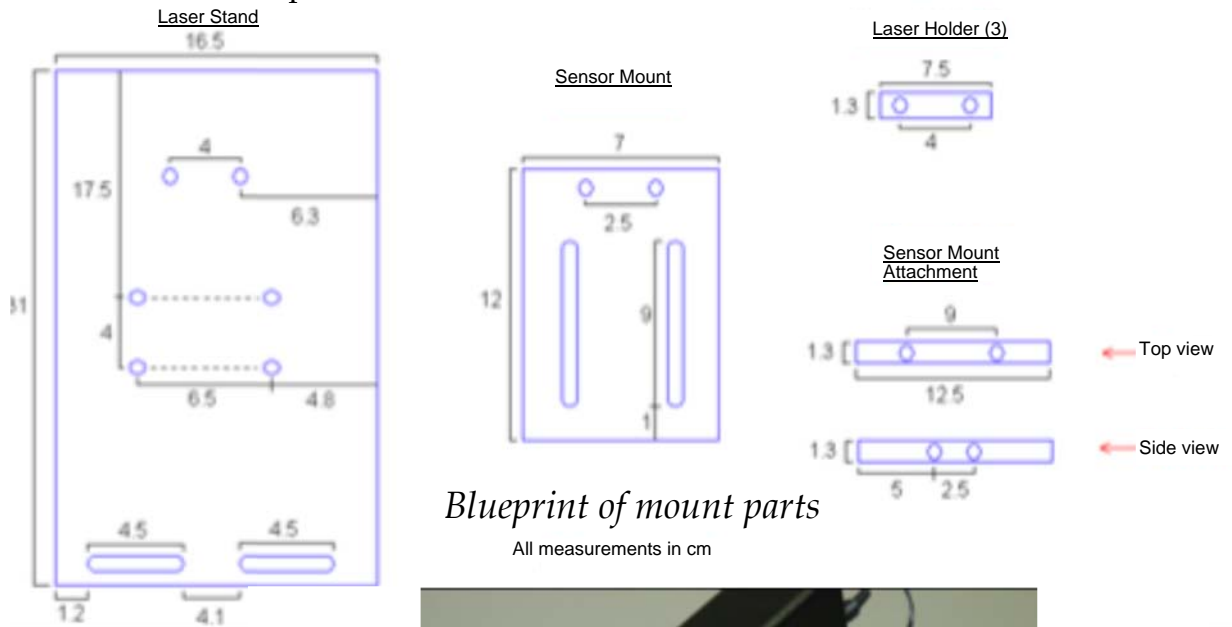

Blueprint of mount parts

All measurements in cm

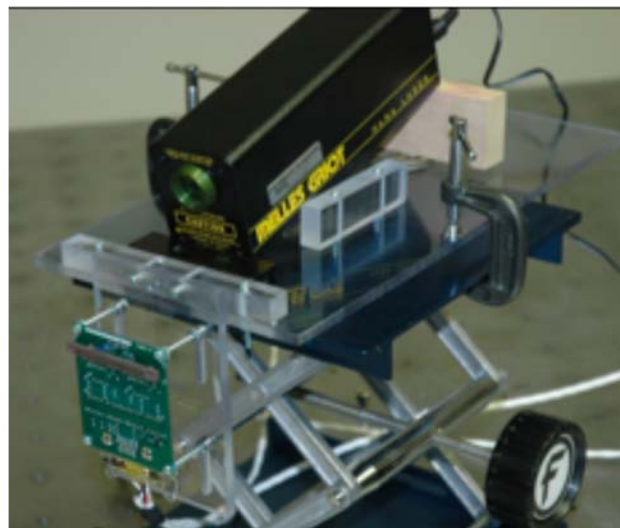

## Events

- ✦ Fri 1 Sep 06: Scots Spirit Day
- ✦ 13 Dec 06: Luce Dinner
- ✦ 26 Sep 06: Summer Research 2006
- ✦ 4 Oct 06: General Meeting
- ✦ 11 Nov 06: Trip to COSI in Columbus
- ✦ 30 Nov 06: Senior I.S. Progress Reports 1
- ✦ 7 Dec 06: Senior I.S. Progress Reports 2
- ✦ 7 Feb 07: General Meeting
- ✦ 28 Mar 07: General Meeting
- ✦ 22 Apr 07: Taylor Bowl 18
- ✦ 28 Apr 07: Indian Dinner

## 2007-2008 Physics Club Officers

- ✦ Danny Tremblay, President
- ✦ Danny Shai, Vice President
- ✦ Stephen Poprocki, Treasurer
- ✦ Kelly Patton, Secretary
- ✦ John Lindner, Faculty Advisor

## Colloquia

- ✦ Dan Gibson, Denison University, Atomic Negative Ions: Sensitive Electron Interferometers or Stock Market Predictors, 26 April 2007
- ✦ Jeffrey Dyck, John Carroll University, Thermoelectric Materials: From Solid State Cooling to Harvesting Waste Heat, 3 April 2007
- ✦ Derek Wilke, Penn State University, Tuning the Upper Critical Field in MgB<sub>2</sub>, 19 February 2007
- ✦ Physics Seniors, The College of Wooster, Senior I.S. Progress Reports 1, 30 November 2006
- ✦ Physics Seniors, The College of Wooster, Senior I.S. Progress Reports 2, 7 December 2006
- ✦ Physics Student Researchers, Summer Research 2006, 26 September 2006



2007 T-shirt: *Dark Side of the Moon...our own version of the Pink Floyd album cover*

# taylor bowl xviii

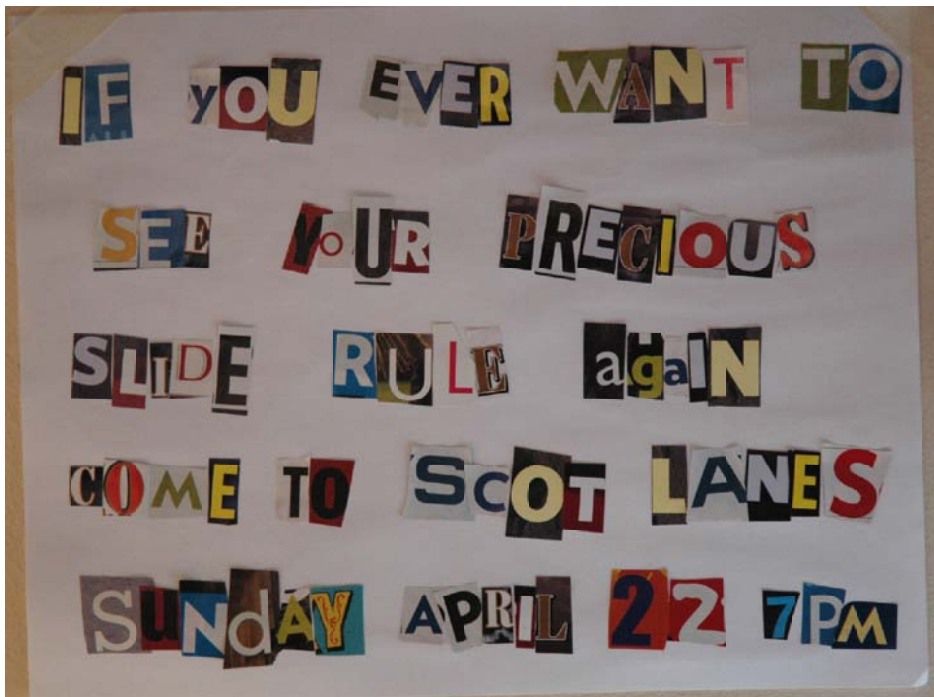

*Ransom note left by slide rule thieves from Physics Department*

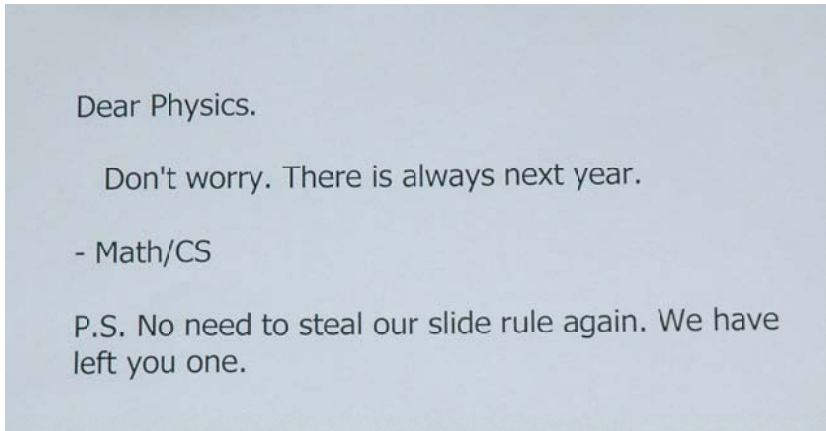

*Note left by Math/CS students after Taylor Bowl XVIII*

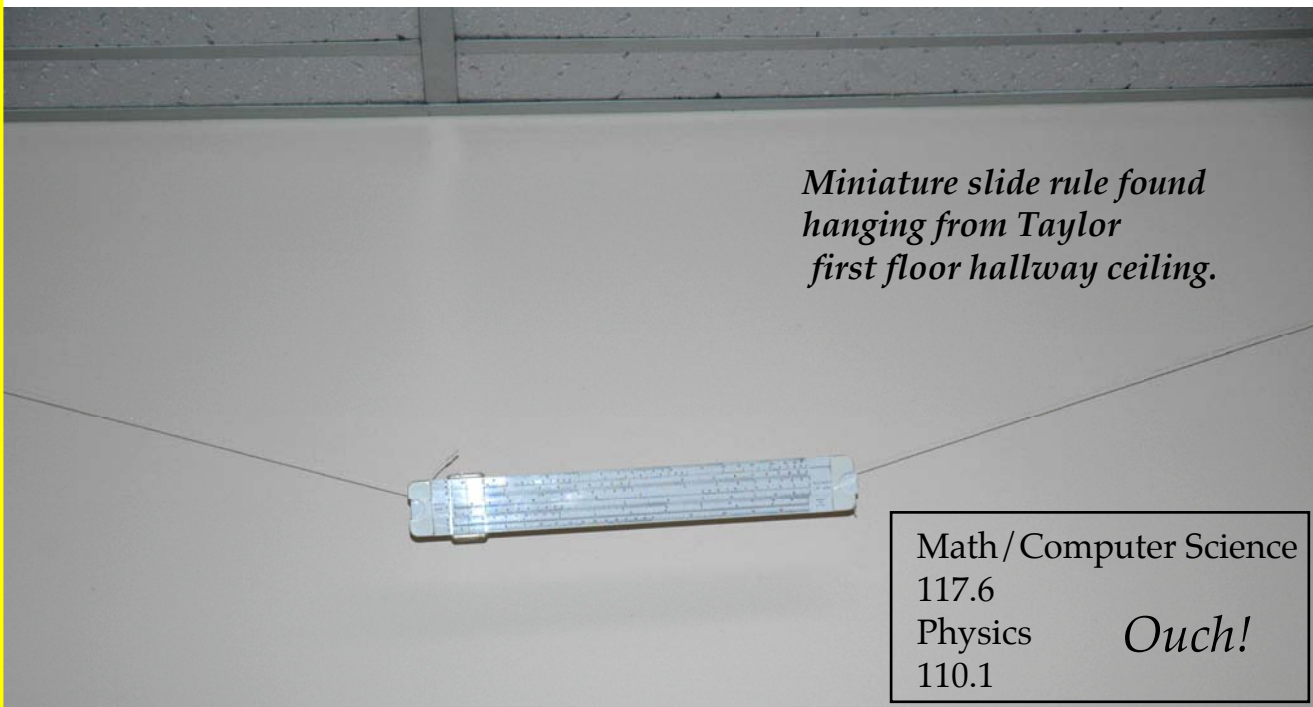

*Miniature slide rule found hanging from Taylor first floor hallway ceiling.*

Math/Computer Science	
117.6	
Physics	<i>Ouch!</i>
110.1	

# Wooster Physics Outreach Wins Two National Awards

## National Organization of the Society of Physics Students

### Blake Lilly Prize

The Blake Lilly Prize recognizes SPS chapters and individuals who make a genuine effort to positively influence the attitudes of school children and the general public about physics. Open to all SPS members and chapters, the award was established by the parents of the late Blake Lilly (a physics student at Georgia Tech who passed away at age 25) and given in his memory.

The three-volume set *The Feynman Lectures on Physics* is given to each school that is awarded the Blake Lilly Prize. Blake Lilly's family said the following:

*"Feynman's real gift may have been that he made physics accessible to students like Blake, who have a compelling interest and commitment, but whose talent lay in diligence and hard, consistent study rather than in super intelligence. Feynman spoke to the ordinary student in Blake about the extraordinary beauty of physics."*

Recipients of the 2007 Blake Lilly Prize are Angelo State University, California State University-Chico, Rowan University, Texas State University, and The College of Wooster.

### Marsh White Award

Marsh W. White Awards are made to Society of Physics Students Chapters "to support projects designed to promote interest in physics among students and the general public." Awards of up to \$300 are made annually on the basis of proposals submitted by active SPS Chapters. From among the proposals submitted by Chapters, a panel of judges selects several of the most meritorious for Marsh W. White awards. The award is funded by the Sigma Pi Sigma Trust Fund.

Wooster Outreach has been awarded its second Marsh White Award and decided to use the award money to add a component to its electricity and magnetism program that would create a larger "wow" factor: a 200,000-volt Van de Graaff generator, a clear plastic container of vermiculite (Volta's Hail Storm), a metallic, spinning pinwheel, a flying metallic ball, a metallic ribbon (silver snake), and electrostatic plume strips.

#### 2006-2007 School Visits

- |   |  |
|---|--|
| ✦ 13 October 2006<br>St. Mary School 3rd grade<br>THEME: Force and Motion       | ✦ 19 January 2007<br>Shreve Elementary 4th grade<br>THEME: Electricity and Magnetism                   |
| ✦ 27 October 2006<br>Wayne Elementary 4th grade<br>THEME: Air Pressure          | ✦ 23 February and 2 March 2007<br>Cornerstone Elementary 5th grade<br>THEME: Electricity and Magnetism |
| ✦ 3 November 2006<br>Parkview Elementary 3rd grade<br>THEME: Force and Motion   | ✦ 9 March 2007<br>Lincoln Way Elementary 5th grade<br>THEME: Electricity and Magnetism                 |
| ✦ 10 November 2006<br>Shreve Elementary 4th grade<br>THEME: Air Pressure        | ✦ 13 April 2007<br>Wayne Elementary 6th grade<br>THEME: Pressure and Air                               |
| ✦ 17 November 2006<br>Mt. Eaton Elementary 4th grade<br>THEME: Air Pressure     | ✦ 20 April 2007<br>Shreve Elementary 4th grade<br>THEME: Force and Motion                              |
| ✦ 1 and 8 December 2006<br>Kean Elementary 3rd grade<br>THEME: Force and Motion | ✦ 27 April 2007<br>Melrose Elementary 3rd grade<br>THEME: Force and Motion                             |

## Robot Invasion!!!

Thanks to support from Morgan-Kauffman planning funds for entrepreneurial activities, Don Jacobs successfully incorporated a robotics project at the end of his Physics 220 Electronics course. The students were broken into three teams and each team decided on a new sensor (one not currently available for the Lego Mindstorms NXT robot kits), made or acquired the sensor, developed the electronics to interface the sensor to the NXT computer, and then developed the software to access the sensor and use it to determine some action for the robot. One group (Frank King, Joe Thomas, Eric Panzner, Max Speth ) built "Unicron", a metal detector that successfully found a metal plate beneath the carpet.

<http://www.wooster.edu/physics/jacobs/220/Robot.html>

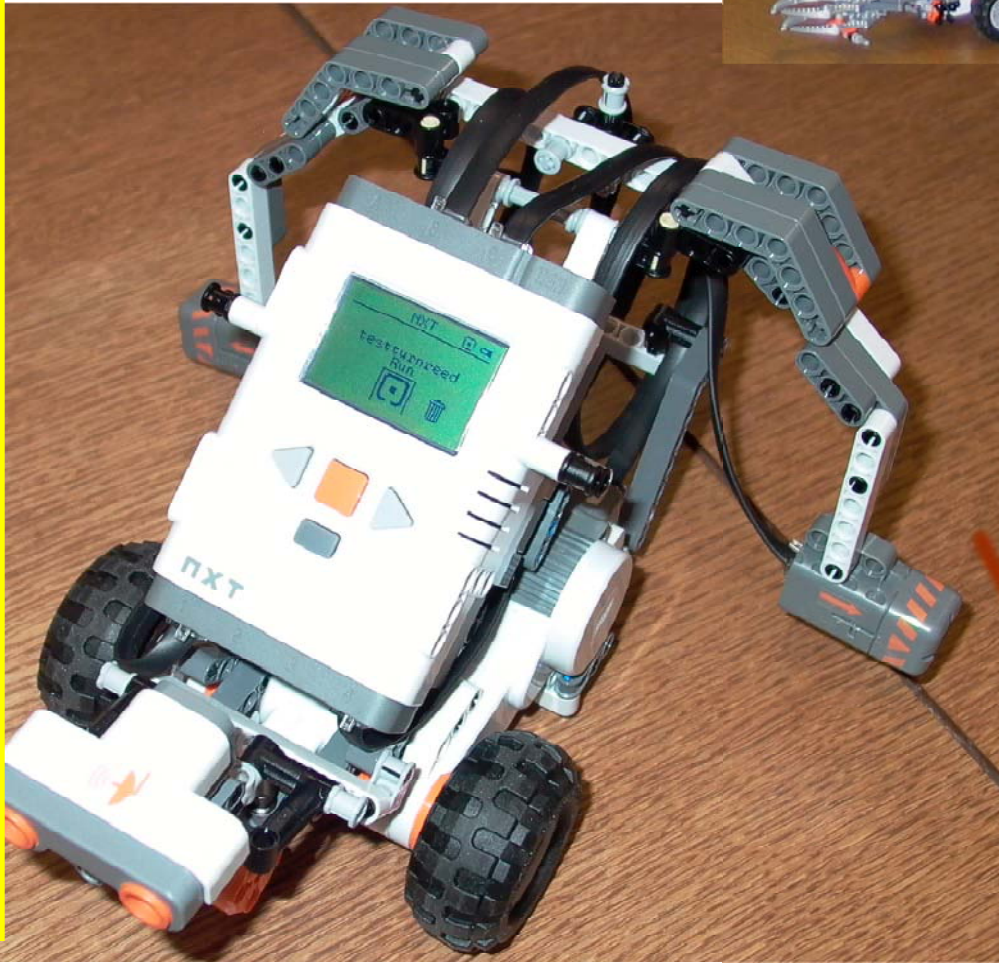

Another group developed "Piggly Wiggly" to measure temperatures between 9 and 99 degrees Celsius (Kirsten Larson, Heather Moore, and Nathan Utt). "Magnet o", developed by Henry Timmers, Myat Tun, and Mike Davis, responded to magnets that enabled it to make right and left hand turns.





*clockwise from left: Susan Lehman and William, John Lindner, Evan Heidtmann, Nathan Utt, Martha Roseberry, Mary Mills, Henry Timmers*

In March, five students and two faculty traveled to Denver for the 2007 National Meeting of the American Physical Society held at the Colorado Convention Center, where students gave poster presentations of their research.

- ✦ Martha I. Roseberry\* & John F. Lindner, "Precession and chaos in the Newtonian two-body problem in a spherical universe"
- ✦ Evan Heidtmann\* & John F. Lindner, "The "Escape Set" elucidates chaos in the restricted three-body problem"
- ✦ Henry Timmers\*, Sarah Suddendorf\*, Angie Triplett\*, Nithya Venkataraman\* & D.T. Jacobs, "Correlation length of a near-critical, eight-arm star polystyrene in methylcyclohexane"
- ✦ Nathan Utt\* & D.T. Jacobs, "Anomaly in the heat capacity of nitrobenzene and dodecane"
- ✦ Mary Mills\*, Andrew Kindschuh\* & D.T. Jacobs, "Self-Organized Criticality in a Bead Pile"

\*student co-author

The National Science Foundation has awarded Wooster Physics Department another four-year Research Experience for Undergraduates grant. This summer, we welcomed five undergraduates from other colleges, four from Wooster, and our first “senior research associate”, a new position designed for a recent graduate who had previously participated in our REU program. The research associate (Danny Shai) not only joined one of our research groups, but he also helped mentor the REU undergraduates.

### Summer 2007 Research Projects

- ✦ COREY ATWOOD-STONE, CoW '10  
Celestial Clock: Tracking the Sun, the Moon, the Center of the Milky Way and the Earth's Velocity Vector with Respect to the CMB (advised by Todd McAlpine)
- ✦ JAMES DANIELS, CoW '10  
A Closer Look at Multiple Time Scales in Transistor Amplifiers (advised by Doug Armstead)
- ✦ JAMES GALLAGHER, Ohio Northern University '10  
Constructing an Array of One-Way Coupled Bistable Oscillators (advised by John Lindner)
- ✦ MATTHEW GORSKI, CoW '09  
Top-down Causation and Cellular Automata (advised by John Lindner)
- ✦ ERIC HARDIN, SLIPPERY ROCK UNIVERSITY '08  
Investigating the Inner Structure of Non-radial  $\beta$ -lactoglobulin Spherulites (advised by Doug Armstead)
- ✦ KASEY KELLY, Kenyon College '10  
Visualizing Curved Spacetime: Light Geodesics in Kerr-Newman Spacetime (advised by John Lindner)
- ✦ FRANK KING, CoW '09  
Charged Spherical Pendulum in Electric and Magnetic Fields (advised by Todd McAlpine)
- ✦ DANIEL SHAI, CoW '07  
Construction of a Ballistic Electron Emission Microscope (advised by Susan Lehman)
- ✦ IAN STEWARD, John Carroll University '08  
Measuring Reflectivity with a Ring-Down Cavity (advised by Susan Lehman)
- ✦ JEREMIAH ZBLEWSKI, University of Wisconsin Stevens Point '07  
Spectral and Computation Studies of Hydrogen Bonding of Uracil and Cytosine with Methanol (advised by Sarah Schmidtke, Chemistry Department)



Row 1: Eric Hardin, Matt Gorski, Danny Shai, Corey Atwood-Stone  
 Row 2: Robby Daniels, Kasey Kelly, Frank King, Susan Lehman, Ian Steward  
 Row 3: Jeremiah Zblewski, Todd McAlpine, Doug Armstead, John Lindner, Sarah Schmidtke, Jim Gallagher

### Off-Campus Summer Research 2007

**Mary Mills '09** did her summer research at the University of Toledo. She studied thin films and the effects of substrate rotation during deposition on the surface morphology and roughness in oblique-incidence epitaxial growth via kinetic Monte Carlo simulations. Her results were compared with previous results obtained without rotation. **Kirsten Larson '08** did research at the University of Hawaii, Institute for Astronomy. Her project was theoretical mid-infrared modeling of starburst galaxies. Galaxy models have been successfully applied to optical data in the past and allow astronomers to gain information about the galaxies and classify them. These models have been recently updated, and Kirsten tested their ability to model starburst galaxies in the mid-infrared. **Evan Heidtmann '09** participated in the first mathematics NSF-REU at the Rochester Institute of Technology in Rochester, NY. His group tried to determine the multicolor Ramsey number  $R(C_4, C_4, C_4, C_4)$  through various computational means, including brute-force overlays of  $C_4$ -free graphs and brute-force incremental vertex extensions. Although this Ramsey number is known to be either 18 or 19, they were unable to determine its precise value despite attempting a number of different approaches to the problem. **Henry Timmers '09** worked at Cornell University in the Laboratory for Elementary Particle Physics designing an optical setup which both shapes a Gaussian laser beam into a flattop profile, as well as relays and demagnifies the beam to a photocathode. This setup will be placed into the photoinjector for the Energy Recovery Linac, a bright x-ray source planned to be built in sight of the Cornell Electron Storage Ring. **Kelly Patton '08** worked at the American Museum of Natural History in New York City. She helped to create a catalog of stars close to the Sun using a proper motion survey. She also searched this catalog for white dwarf candidates close to the Sun. **Mark Wellons '08** worked at UC Davis and studied the quantized circulation in superfluid helium vortices, particularly the effects of cell design perturbations on vortex behavior. **John Gamble '08** developed and implemented numerically a quantum algorithm to simulate a seven-spin disordered quantum Ising system on a quantum computer at Los Alamos National Laboratories.

**Scott Hughes '01** received his Ph.D. in astrophysics from Washington University St. Louis and is now employed as a Research Scientist at Stereotaxis, Inc ([www.stereotaxis.com](http://www.stereotaxis.com)) with fellow Woo alum **Paul Rebillot '99**. **Nick Hanson '03** graduated last December from the Physics Entrepreneurship Program (Master of Science) at Case Western Reserve University. He formed a company that specializes in remote sensors for water contamination in fuel on aircraft carriers. **Cy Screwvala '96** teaches mathematics and physics at Greensburg Community High School in Greensburg, IN. Cy recently attended an Advanced Placement conference and hopes to teach AP physics in addition to AP calculus that he currently teaches. **Michael Hunter '94** spent six years working for NASA and now is director of software development for The Builders Exchange, a company that writes imaging and database software for the construction industry. He lives in Middleburg Heights, OH. **Salman Saeed '96** works in San Diego at QUALCOMM in their MEMS technologies group. He is heading the applications engineering group. **Dan Brubaker '03** is teaching science at Crestwood High School in Mantua, OH. **Kevin Andrews '87** works for Nine Sigma Inc. in Beachwood OH, a technology broker. **Anna Ploplis Andrews '87** is working in plastics at AmeriChem Inc. Kevin, Anna, and their two children recently moved to a different area of Medina, OH where they can keep their horses. **Alice Churukian '91** has accepted a Lecturer/Physics Education/Teacher Training position at University of North Carolina Chapel Hill. **Nathan Schiffrik '99** just finished his master's degree in mechanical engineering at Johns Hopkins University and is working as a senior design engineer at Northrop Grumman, designing radar systems. His wife Leah Montesano '98 is an attorney working for a large firm in DC. They have two daughters, Elianna age 8 and Clairra age 6, and live in Laurel, MD. **Brad Lignoski '03** just finished building a raft and floating for a month on the Yukon River. He has been living in Seattle and teaching high school math and physics at a school called Hillside Student Community.



*Anna Ploplis Andrews '87 and Ann Mowery '82 at Alumni Weekend 2007.*

phun stuff

Joe Neff '93 with Dr. Lindner, preparing for a presentation to a Trustee Committee in 1993. Apparently the dress code was much stricter back then.



The Physics Reading Room couch.....should you sit on it?

outline of couch potato's head

original color undeterminable (aqua???)

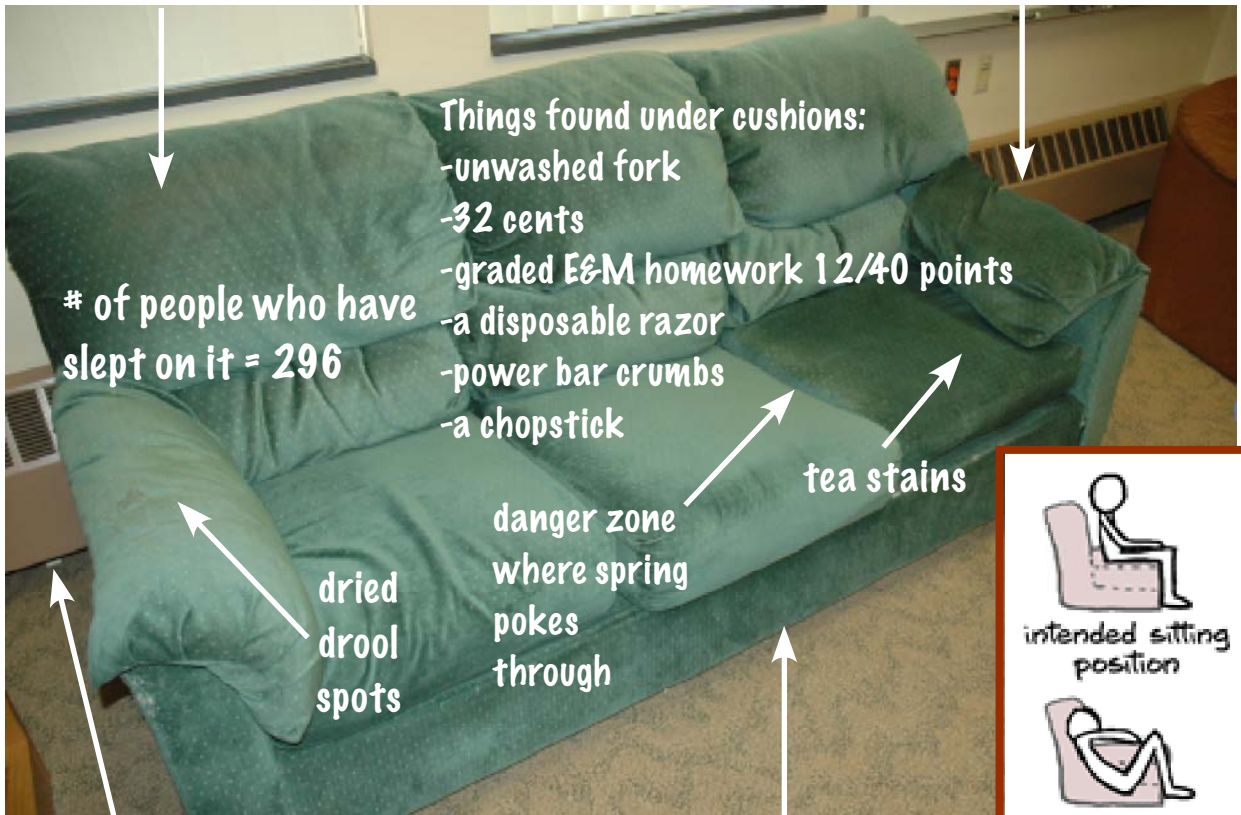

insect trap

declared a biological hazard by college environmental safety officer



[www.wooster.edu/physics](http://www.wooster.edu/physics)

